

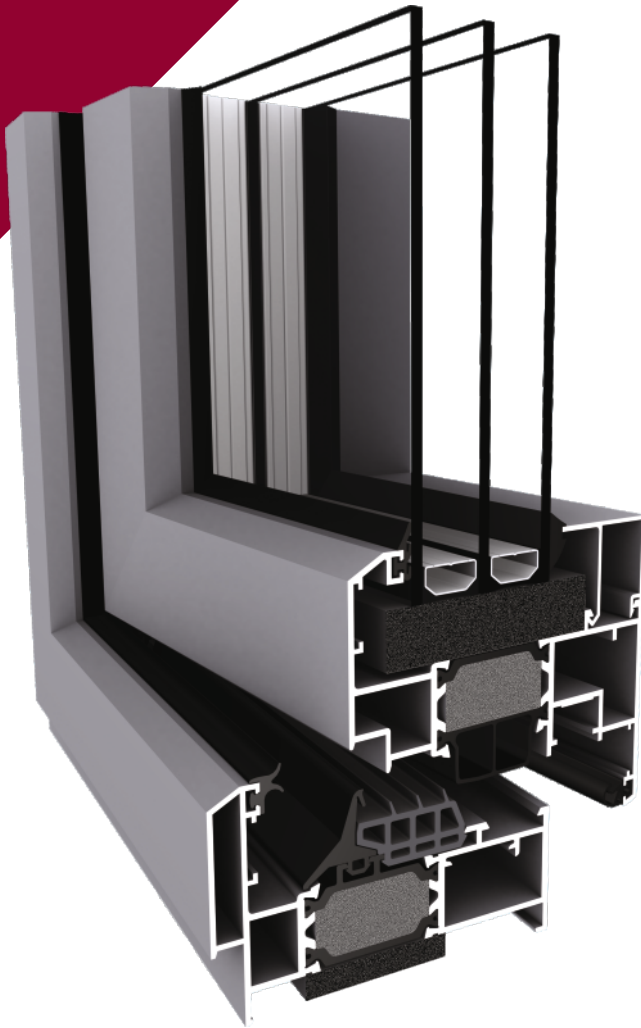

CODALMHA, S.L.
COMERCIAL DEL ALUMINIO



CARACTERÍSTICAS TÉCNICAS

- Sistema practicable, canal de 16.
- Sección de marco de 80 mm.
- Sección vista de 102,4 mm.
- Poliamidas de 34 mm.
- Poliéstileno expandido de 15 kg/m³ con grafito entre las poliamidas.
- Junta térmica de EPDM Expanso.
- Espuma térmica colocada en el galce de los vidrios y en el exterior de marcos.
- Sistema de estanqueidad de Triple junta.
- Juntas central e interior de hoja de EPDM.
- Desagüe oculto en los marcos.
- Posibilidad de triple vidrio.
- Acristalamiento máximo de 62 mm.
- Sistema de escuadras de tetón móvil ó de bloqueo en el tubular interior y de bloqueo en marcos y hojas.
- Sistema con posibilidad de acabado bicolor.
- Posibilidad de colocación de herraje oculto.

VALORES DE ENSAYO

Agua	Aire	Viento	Uw	Ruido
E2100	4	C5	1,2 W/m ² K	<42 dB

(Térmico calculado para Ventana de 2 hojas de medida 1,2x1,5 m con un Uw de 0,7 W/m²K e intercalario no metálico)

SECCIÓN

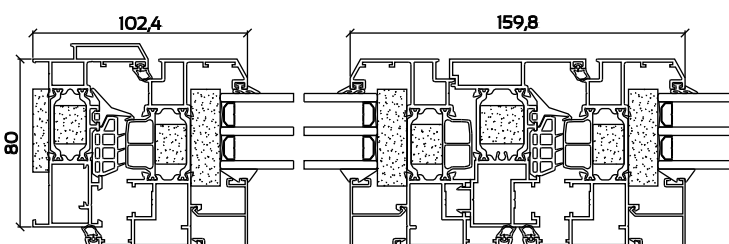

APERTURAS

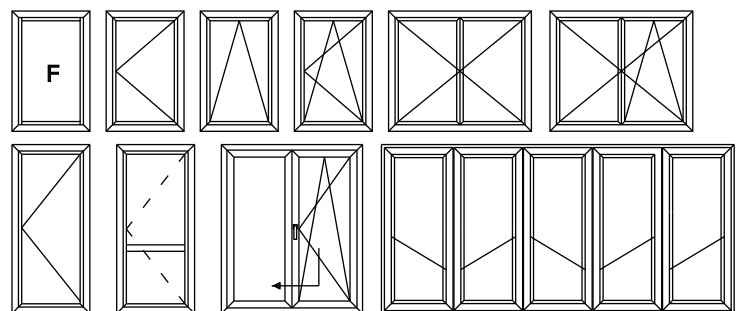

TÉRMICO

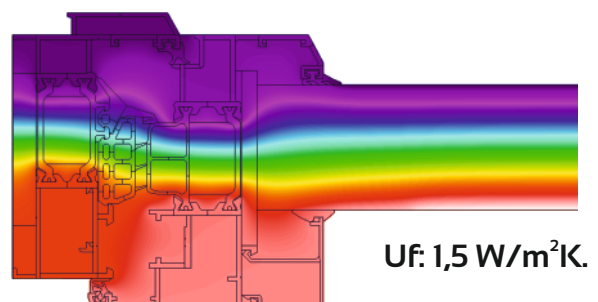

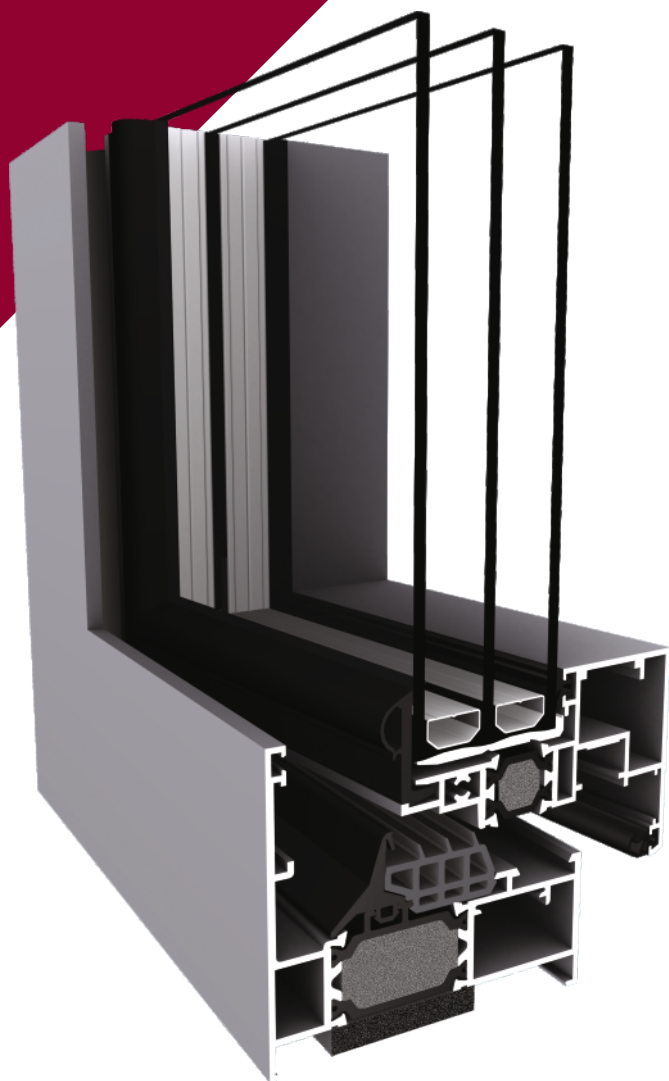

CARACTERÍSTICAS TÉCNICAS

- Sistema practicable, hoja oculta canal de 16.
- Sección de marco de 80 mm.
- Sección vista de 70 mm.
- Poliamidas de 34 mm.
- Poliestileno expandido de 15 kg/m³ con grafito entre las poliamidas.
- Junta térmica de EPDM Expanso.
- Espuma térmica colocada en el exterior de marcos.
- Sistema de estanqueidad de Triple junta.
- Juntas central e interior de hoja de EPDM.
- Acristalamiento mediante junquillo de coextrusión de PVC.
- Desagüe oculto en los marcos.
- Posibilidad de triple vidrio.
- Acristalamiento máximo de 36 mm.
- Calzo acristalamiento de aluminio, en la hoja.
- Sistema de escuadras de tetón móvil ó de bloqueo en el tubular interior y de bloqueo en marcos.
- Perfil inversor con postizo.
- Sistema con posibilidad de acabado bicolor.
- Posibilidad de colocación de herraje oculto.
- Tornillo seguridad en la nariz de la hoja.

VALORES DE ENSAYO

Agua	Aire	Viento	Uw	Ruido
E1050	4	C5	1,2 W/m ² K	<42 dB

(Térmico calculado para Ventana de 2 hojas de medida 1,2x1,5 m con un Uw de 0,7 W/m²K e intercalario no metálico)

SECCIÓN

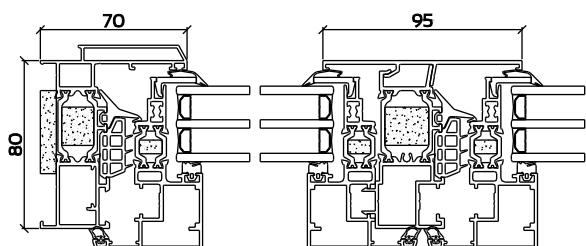

APERTURAS

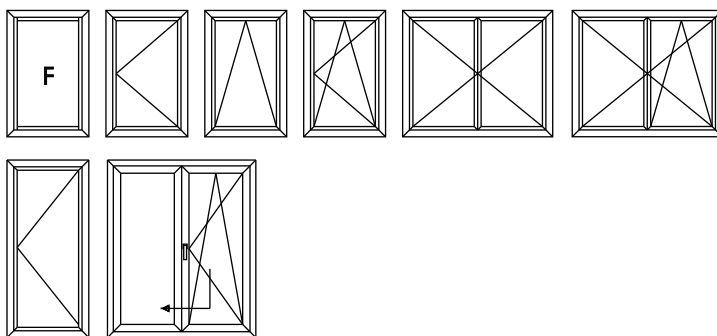

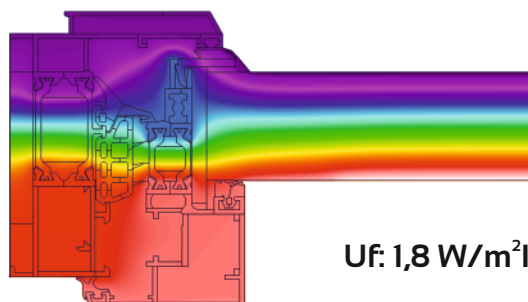

TÉRMICO



Uf: 1,8 W/m²K.

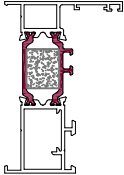
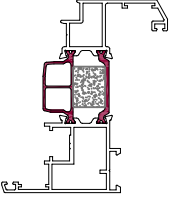
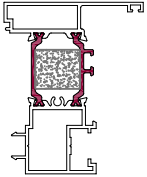
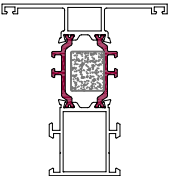
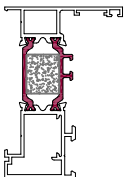
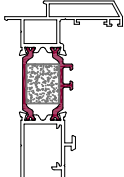

GLOSARIO

Referencia	Dibujo	Descripción	Momento de Inercia cm ⁴		Perímetro dm ²
			lx	ly	
6000		Marco ventana	38,48	6,04	54,0
6001		Hoja ventana	59,32	14,29	69,9
6002		Inversor	43,47	10,9	65,3
6004		Travesaño 33 mm	44,29	11,73	60,2
6006		Marco guía renovación	39,95	6,75	66,9
6007		Marco desagüe oculto	47,97	7,86	62,9
6010		Unión de marcos	9,26	23,05	33,4

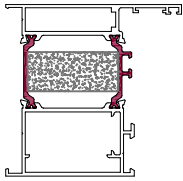
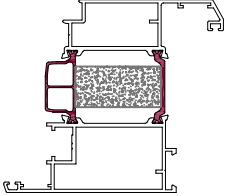
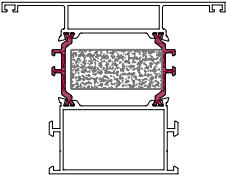
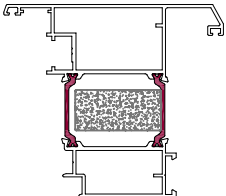
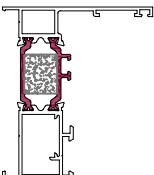
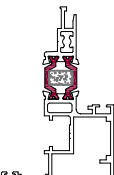
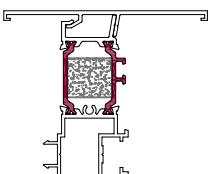

GLOSARIO

Referencia	Dibujo	Descripción	Momento de Inercia cm ⁴		Perímetro dm ²
			ix	ly	
6020		Marco puerta	57,10	26,34	76,4
6021		Hoja puerta	77,87	41,45	90,8
6024		Travesaño 60 mm	61,27	37,03	81,9
6028		Hoja apertura exterior	73,24	40,69	89,7
6050		Marco ventana H.O.	42,13	11,05	57,0
6051		Hoja ventana H.O.	28,93	6,87	60,3
6052		Inversor H.O.	53,15	20,40	73,3

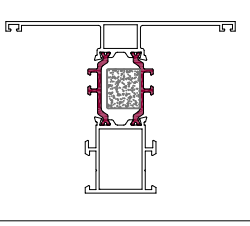
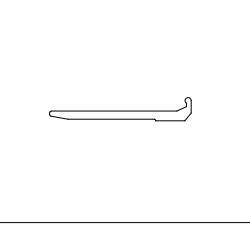
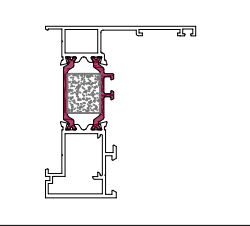
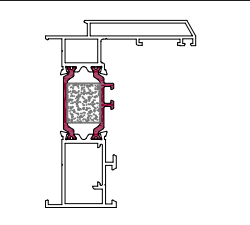
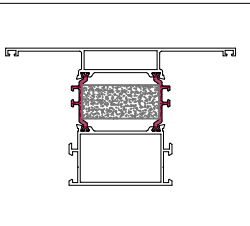
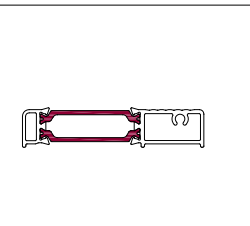
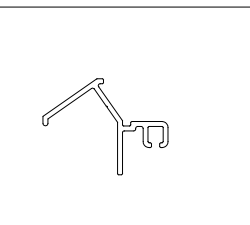

GLOSARIO

Referencia	Dibujo	Descripción	Momento de Inercia cm ⁴		Perímetro dm ²
			ix	ly	
6054		Travesaño 33 mm H.O.	50,72	24,94	66,2
6055		Calzo vidrio H.O.			9,83
6056		Marco guía renovación H.O.	43,82	11,95	58,9
6057		Marco desagüe oculto H.O.	53,31	15,64	68,9
6064		Travesaño 60 mm H.O.	68,61	60,02	88,7
6040		Solera	7,93	20,84	31,4
5051		Perfil remate			14,1



6007 Marco desagüe oculto

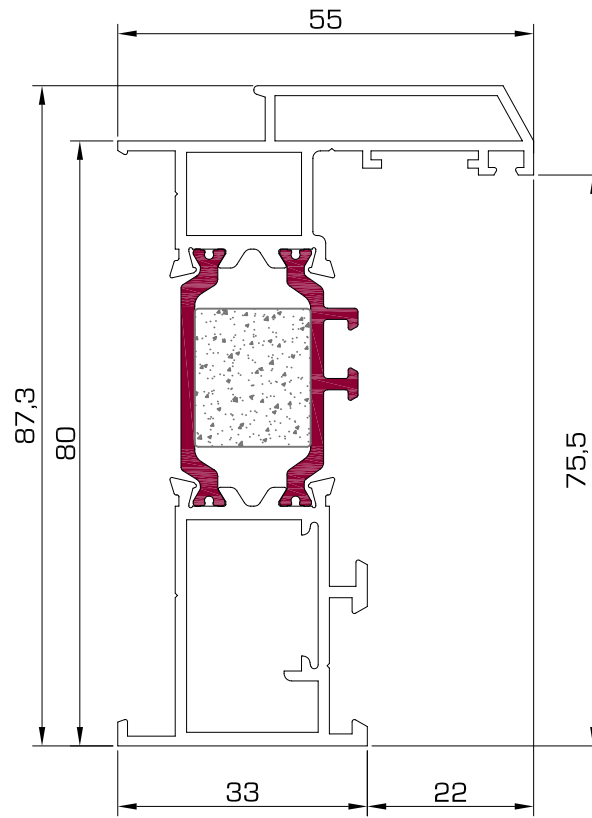

6000 Marco ventana

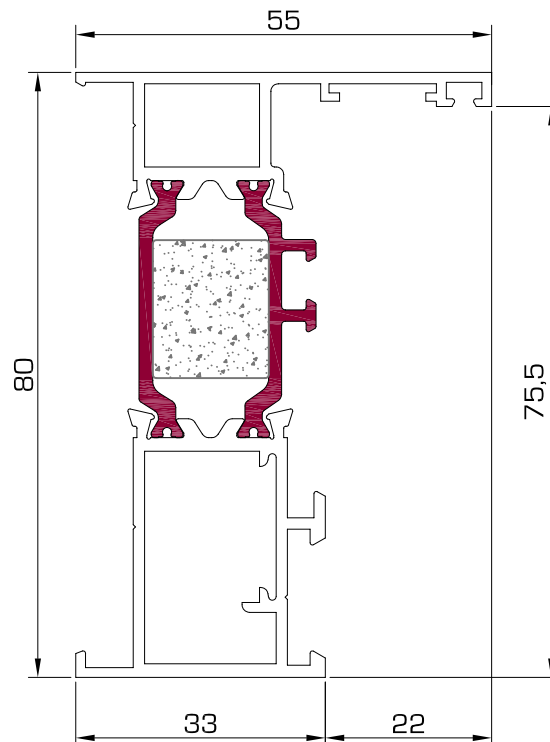



6006 Marco guía renovación

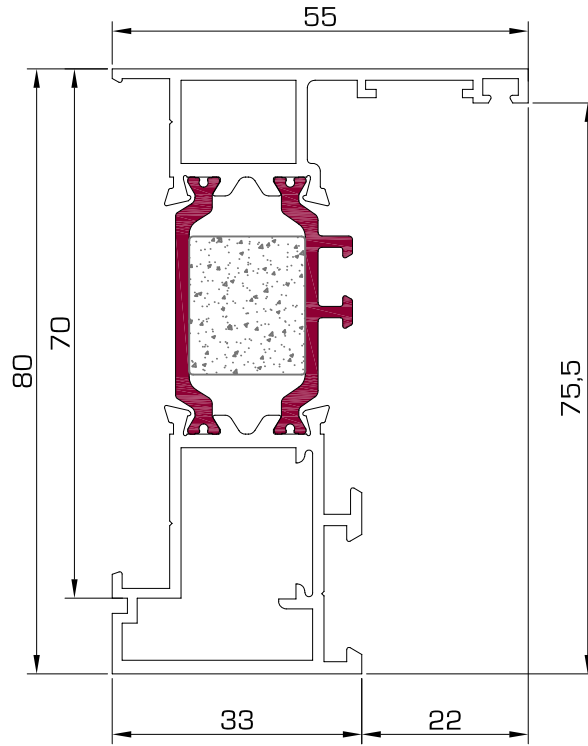

6020 Marco puerta

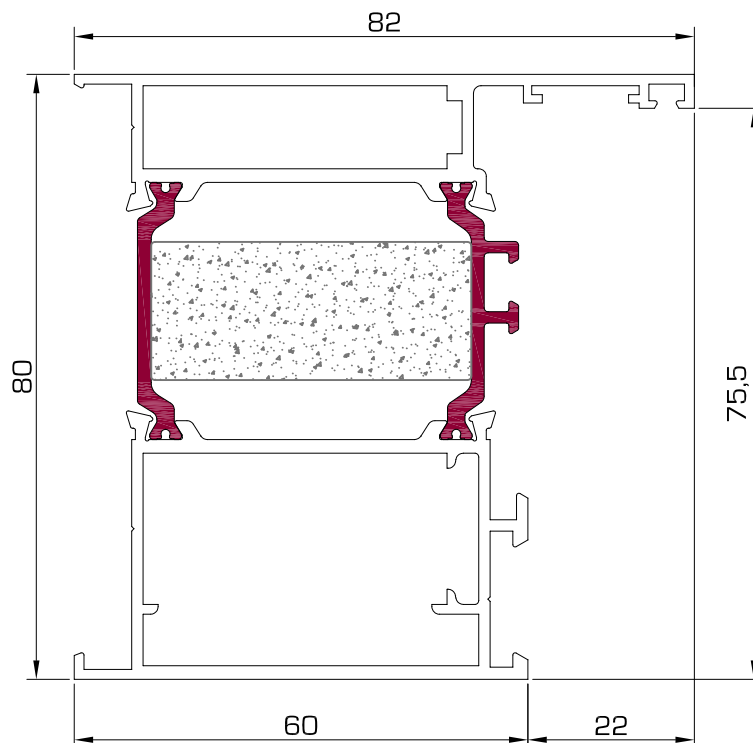

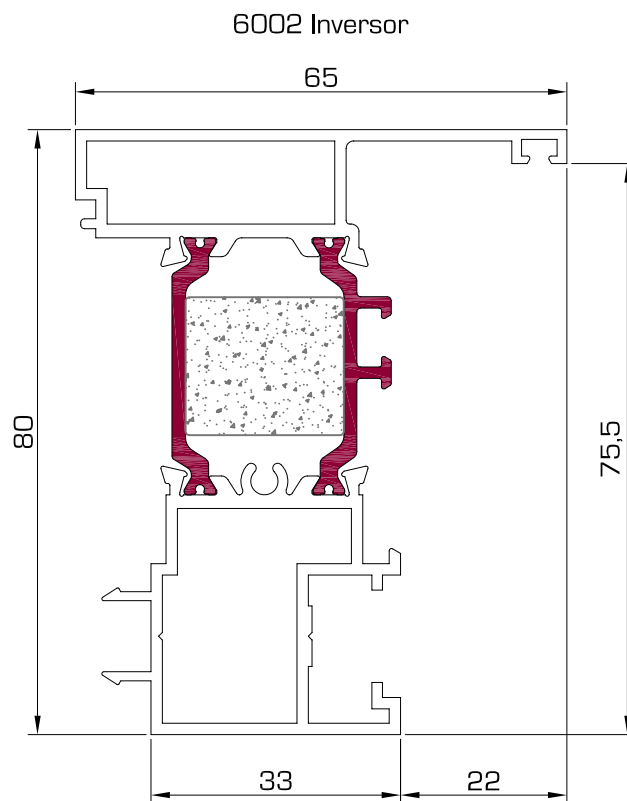



6001 Hoja ventana

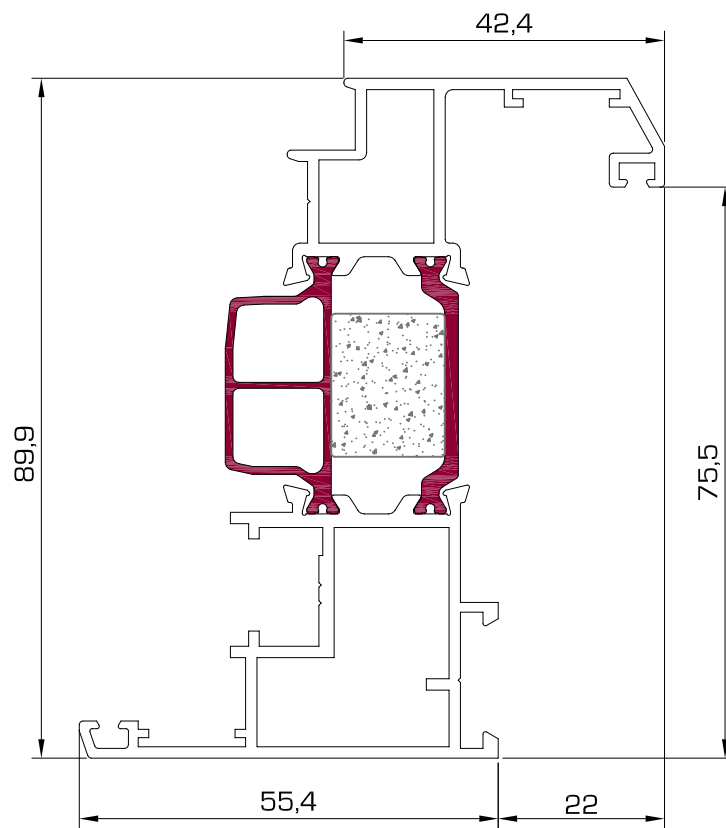

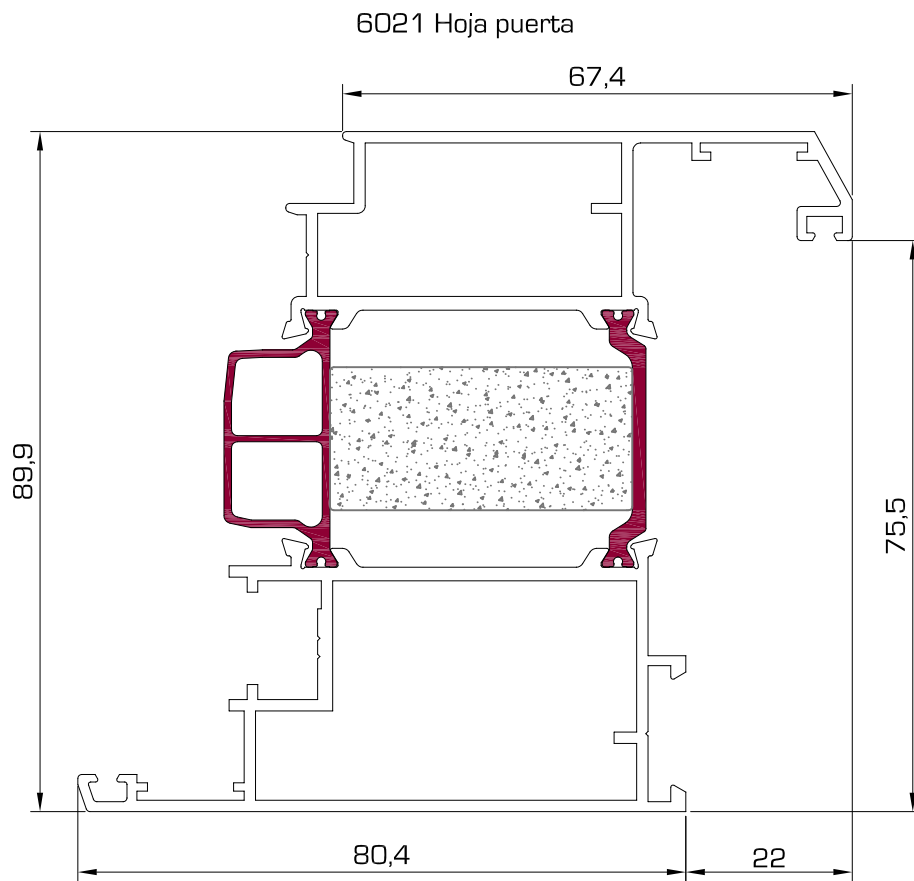

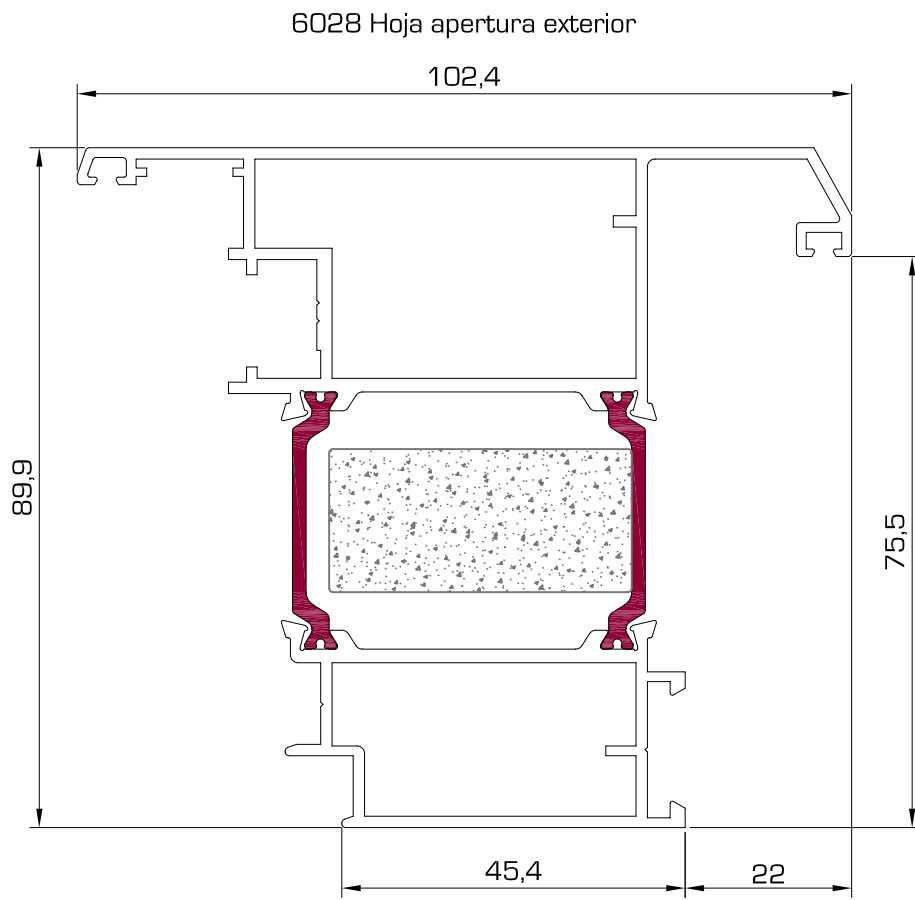



6004 Travesaño 33 mm

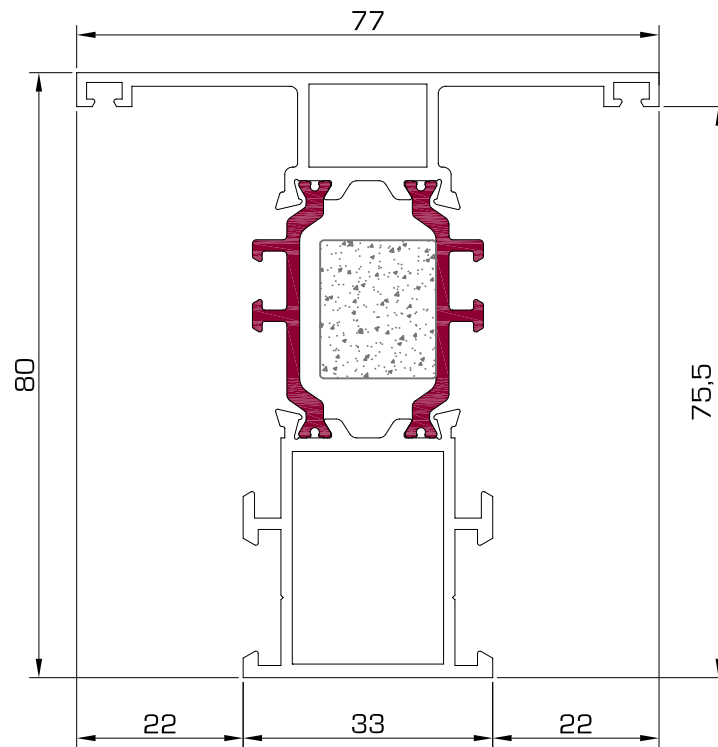

6024 Travesaño 60 mm

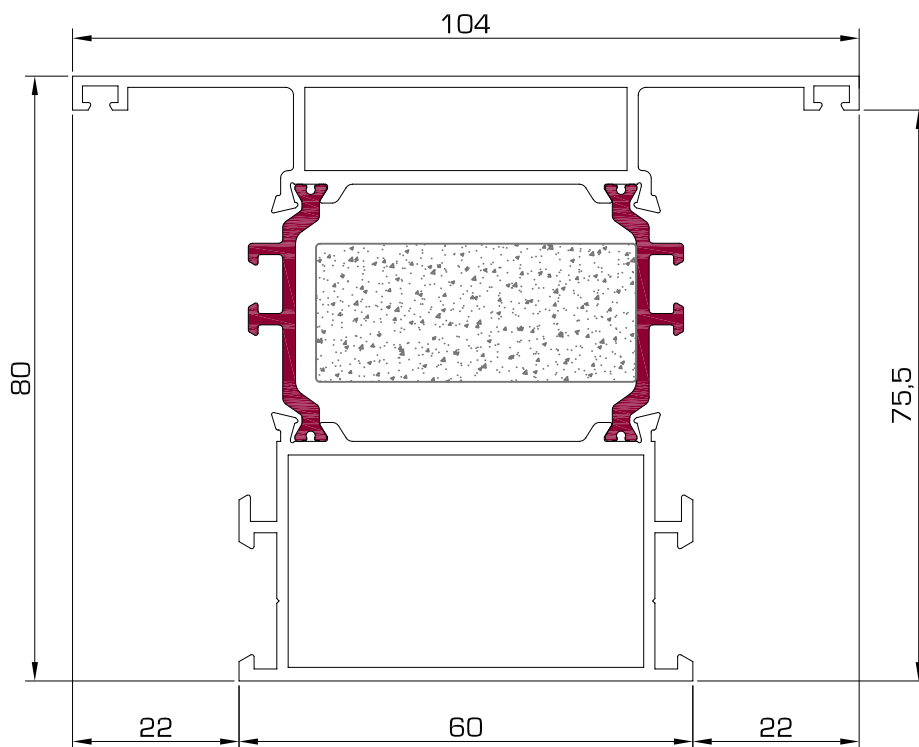



6040 Solera 80 mm

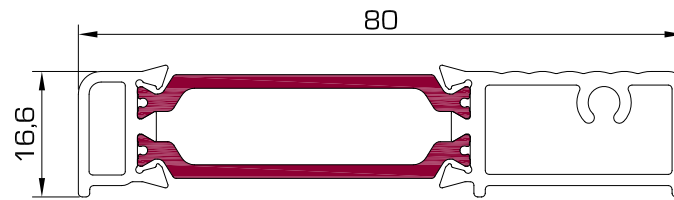

5051 Perfil remate

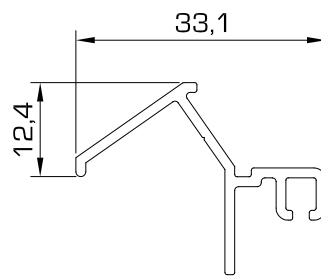

6010 Unión de marcos

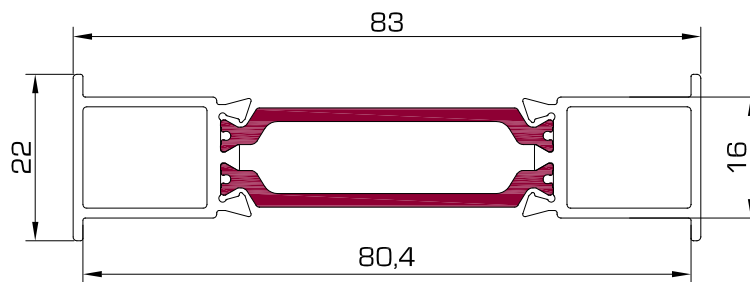



6013 Junquillo 41,5 mm

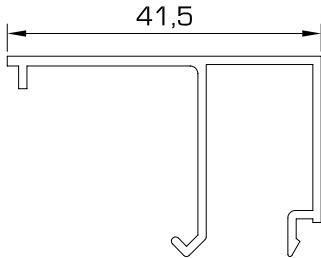

1406 Junquillo 33 mm

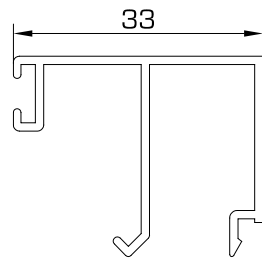

1438 Junquillo 33 mm

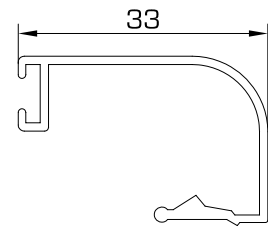

1413 Junquillo 28 mm

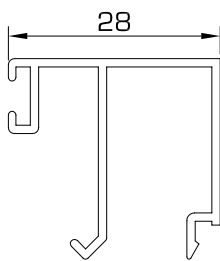

1436 Junquillo 28 mm

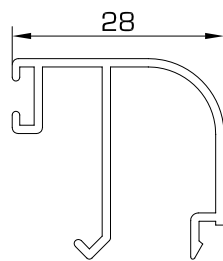

1409 Junquillo 28 mm

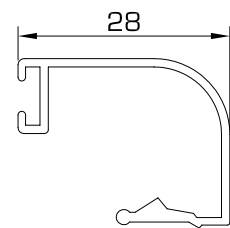

5011 Junquillo 25,5 mm

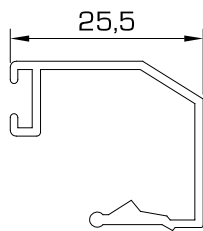

5013 Junquillo 25 mm

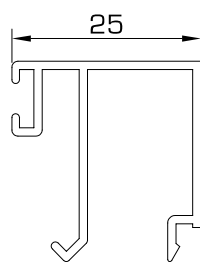

1414 Junquillo 21 mm

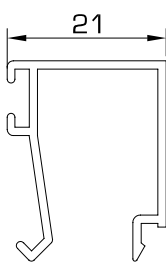

1410 Junquillo 21 mm

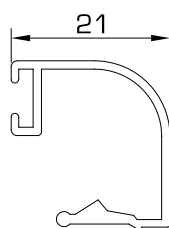

5012 Junquillo 20,5 mm

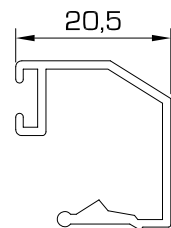

1415 Junquillo 18 mm

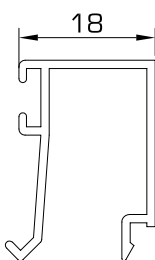

1439 Junquillo 18 mm

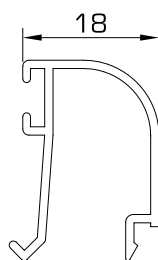

1411 Junquillo 18 mm

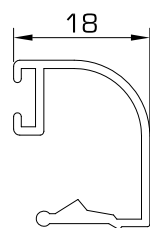



1416 Junquillo 14 mm

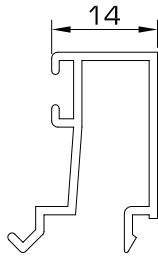

1437 Junquillo 14 mm

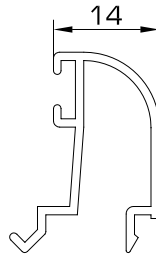

1412 Junquillo 15 mm

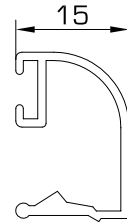

1417 Junquillo 10 mm

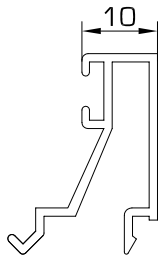

1407 Junquillo 10 mm

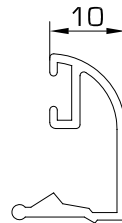



6057 Marco desagüe oculto H.O.

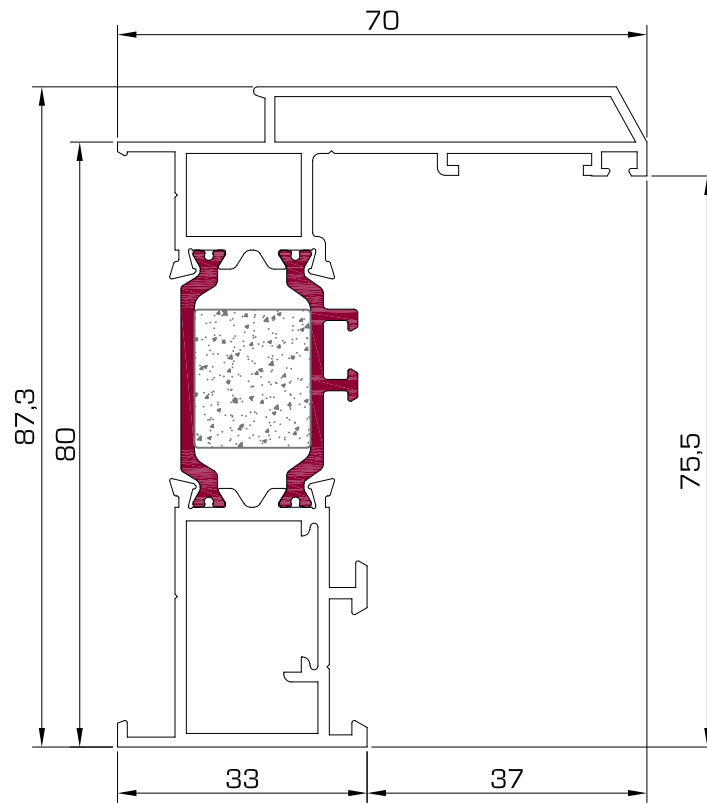

6050 Marco ventana H.O.

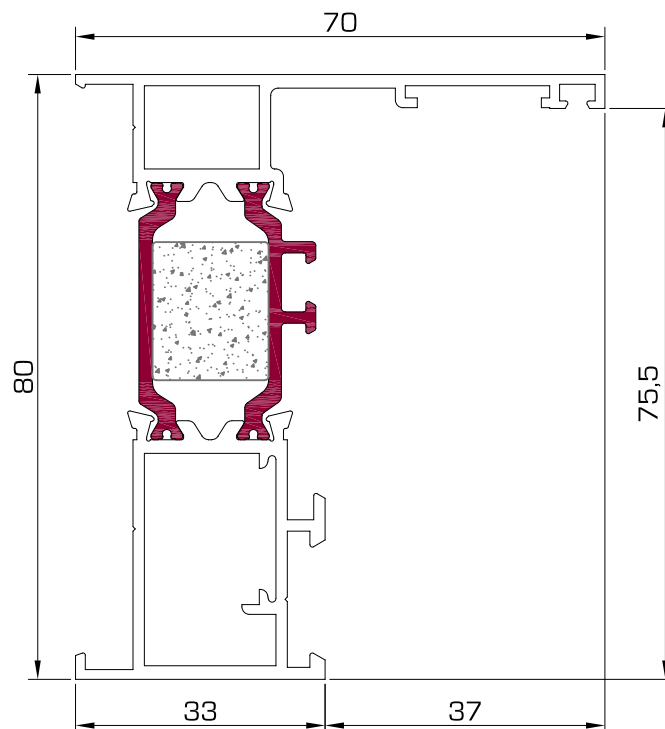



6056 Marco guía renovación H.O.

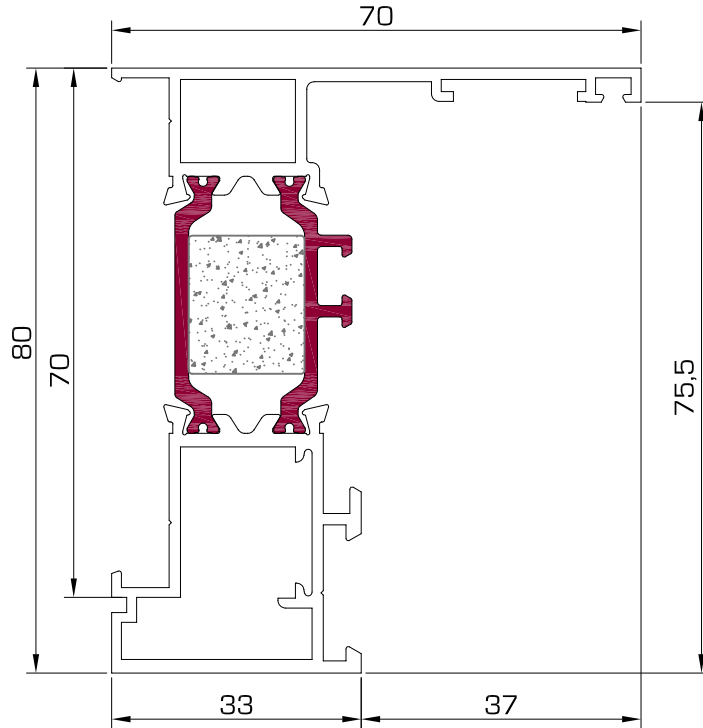

6052 Inversor H.O.

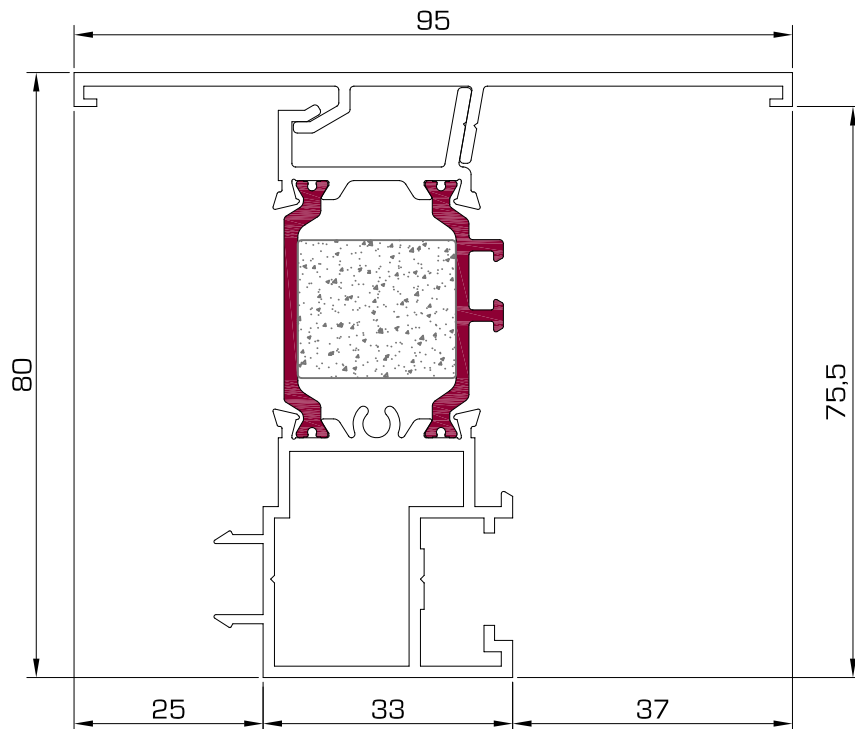



6051 Hoja ventana H.O.

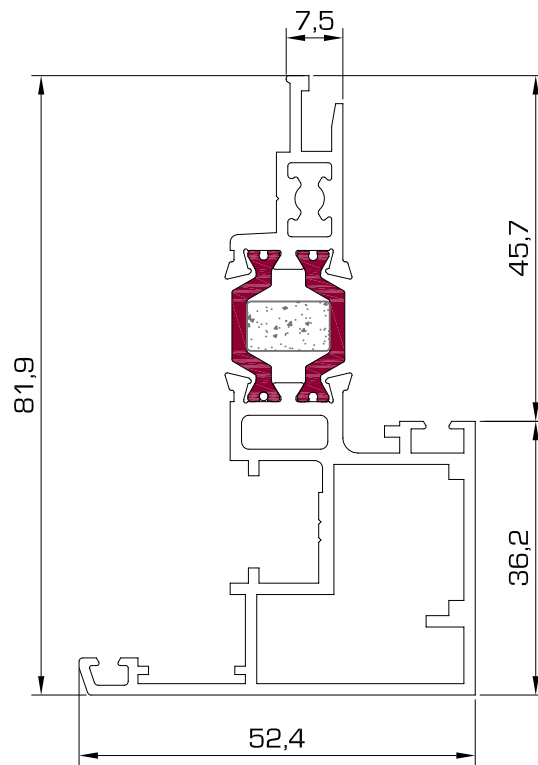

6055 Calzo vidrio H.O.

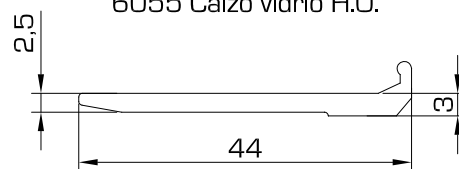



6054 Travesaño 33 mm H.O.

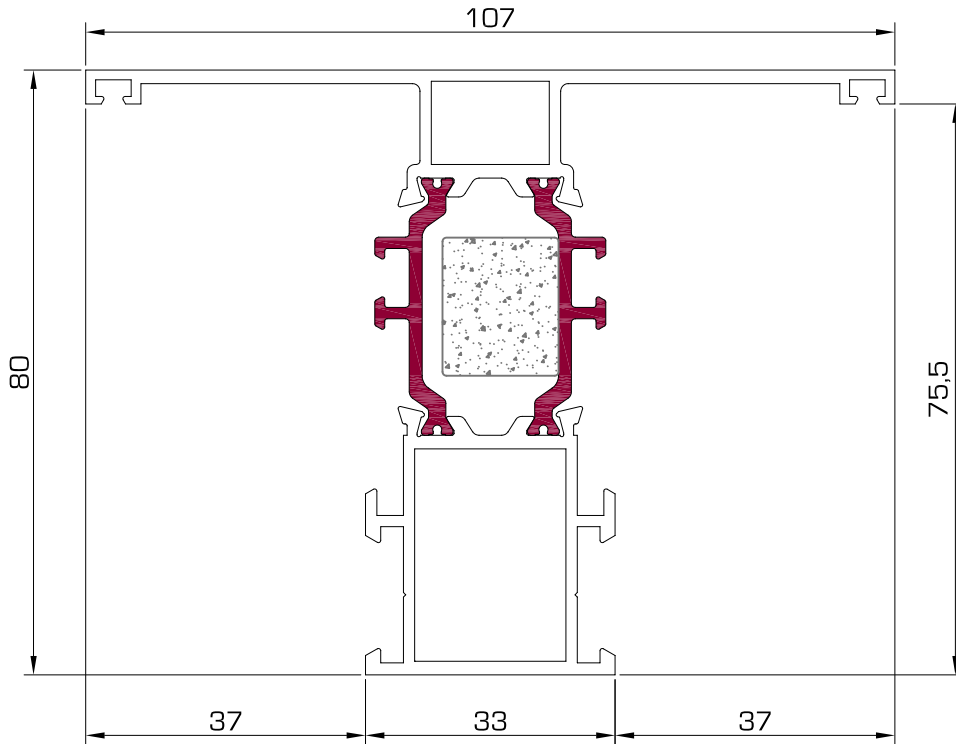

6064 Travesaño 60 mm H.O.

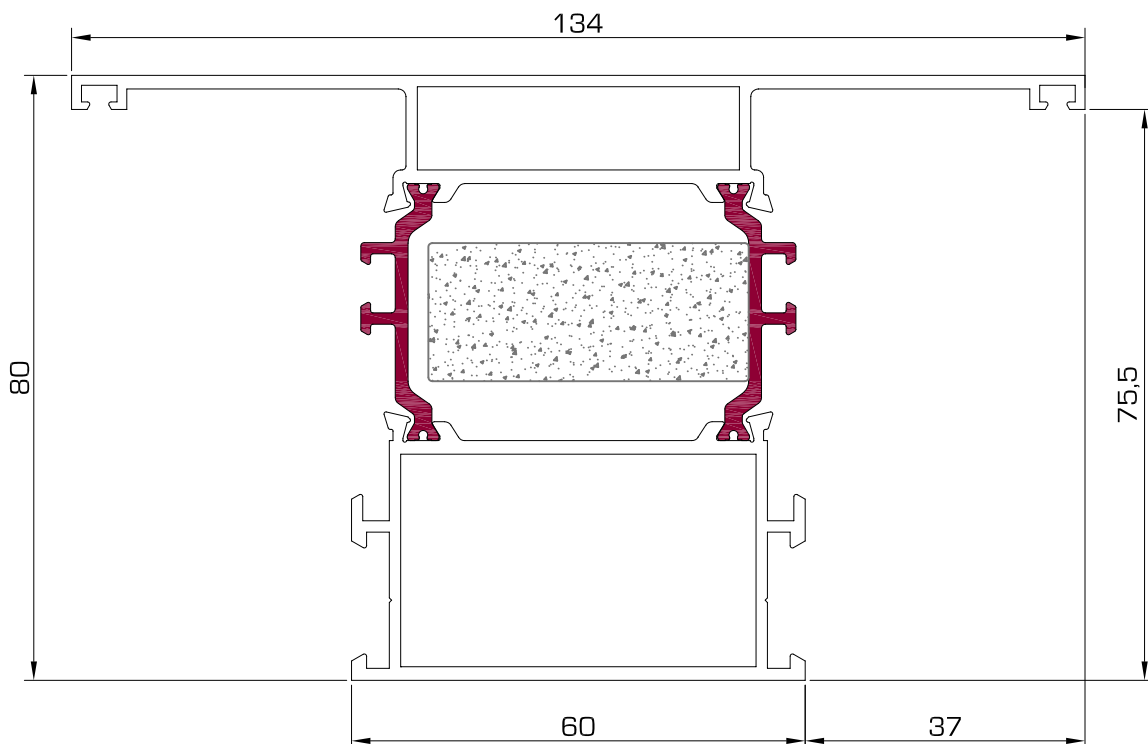



6074 Junquillo 30,5 mm H.O.

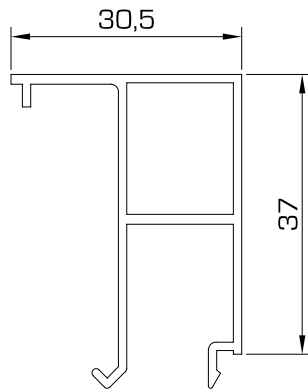

6073 Junquillo 38,5 mm H.O.

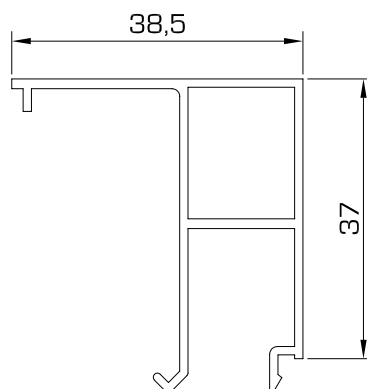





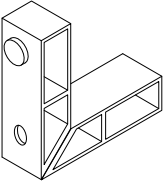
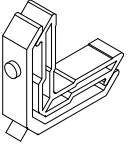
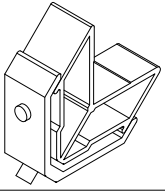
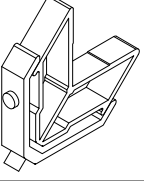
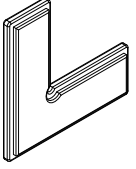
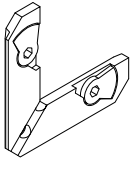
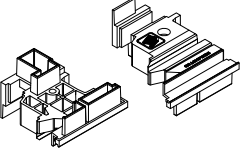
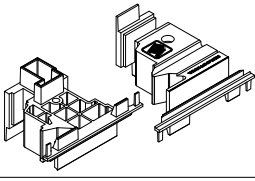
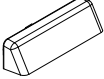

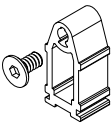
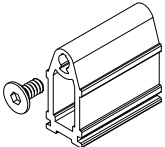

ACCESORIOS

Referencia	Dibujo	Descripción	Observaciones
E080		Escuadra ventana interior	
E081		Escuadra ventana exterior	
E084		Escuadra puerta interior	
E085		Escuadra puerta exterior	
E031		Escuadra de alineamiento	
E090		Escuadra Fuji marco Hoja Oculta	
K080		Juego tapones de inversor	
K081		Juego tapones de inversor Hoja Oculta	
T040		Salida de agua	

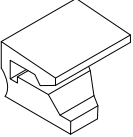
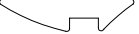

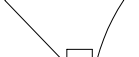
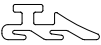
ACCESORIOS

Referencia	Dibujo	Descripción	Observaciones
U008		Tope unión de travesaño ventana	
U009		Tope unión de travesaño puerta	
1453		Cepillo inferior	
G100		Grapa sujección junquillo curvo	
G001		Goma de cuña de 2 mm	
G002		Goma de cuña de 4 mm	
G015		Goma de cuña de 7 mm	
G077		Goma exterior para acristalado	
G069		Goma batiente exterior marco	



ACCESORIOS

Referencia	Dibujo	Descripción	Observaciones
G049		Goma batiente hoja	
G090		Goma junta central	
G091		Goma junta central refuerzo térmico	
U080		Junquillo PVC hoja oculta	
G098		Goma acristalar vidrio 36 mmH.O.	
G094		Goma acristalar vidrio 28 mm H.O.	
F080		Espuma térmica 50x10	
F081		Espuma térmica galce vidrio 50x15	



ACRISTALAMIENTO

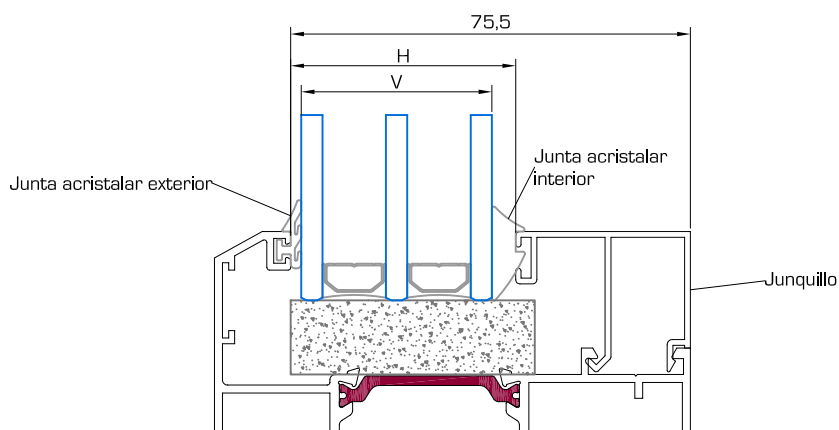

Junquillo	Hueco (H)	Junta exterior	Junta interior	Medida Vidrio (V)
6013 (41,5 mm) recto clip	34 mm	G077	G001	30
			G002	28
1406 (33 mm) recto clip	42,5 mm	G077	G001	38
1438 (33 mm) Curvo grapa			G002	36
1413 (28 mm) recto clip	47,5 mm	G077	G001	43
1436 (28 mm) curvo clip			G002	41
1409 (28 mm) curvo de grapa				46
5011 (25,5 mm) chaflán de grapa	50,5 mm	G077	G001	46
5013 (25 mm) recto clip			G002	44
1414 (21 mm) recto clip	54,5 mm	G077	G001	50
1410 (21 mm) curvo grapa			G002	48
5012 (20,5 mm) chaflán grapa				53
1415 (18 mm) recto clip	57,5 mm	G077	G001	53
1439 (18 mm) curvo clip			G002	51
1411 (18 mm) curvo grapa				56
1412 (15 mm) curvo grapa	60,5 mm	G077	G001	56
			G002	54
1416 (14 mm) recto clip	61,5 mm	G077	G001	57
1437 (14 mm) curvo clip			G002	55
1417 (10 mm) recto clip	65,5 mm	G077	G001	61
1407 (10 mm) curvo grapa			G002	59



ACRISTALAMIENTO

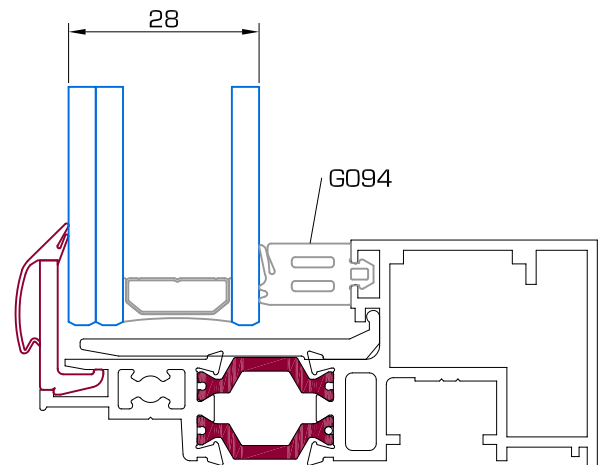
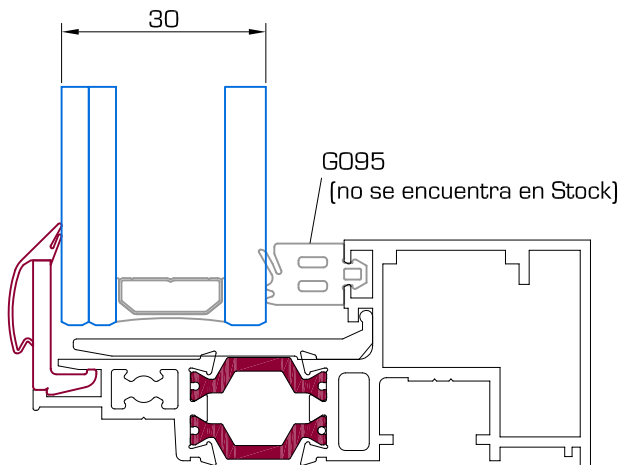
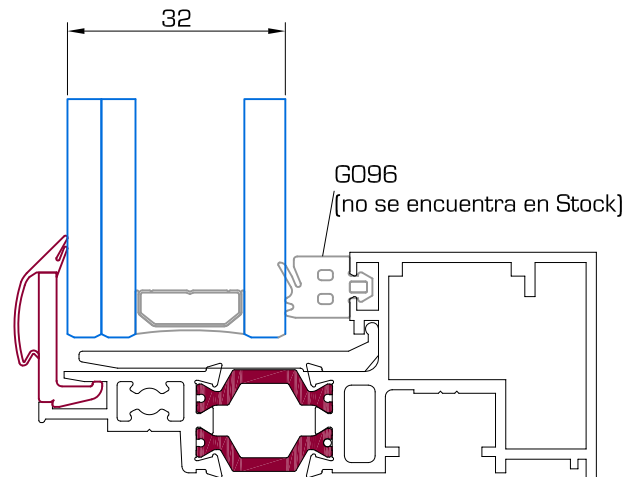
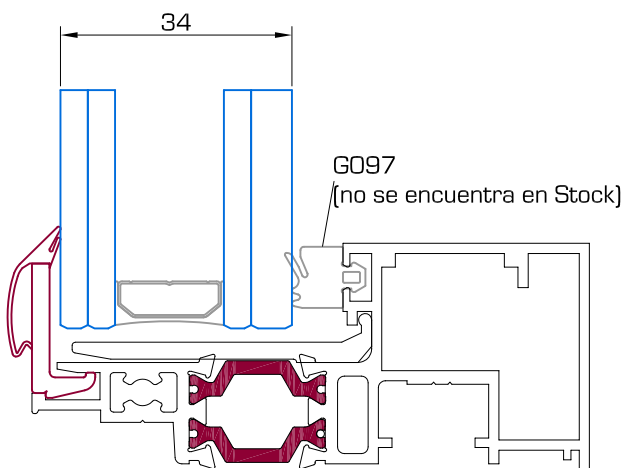
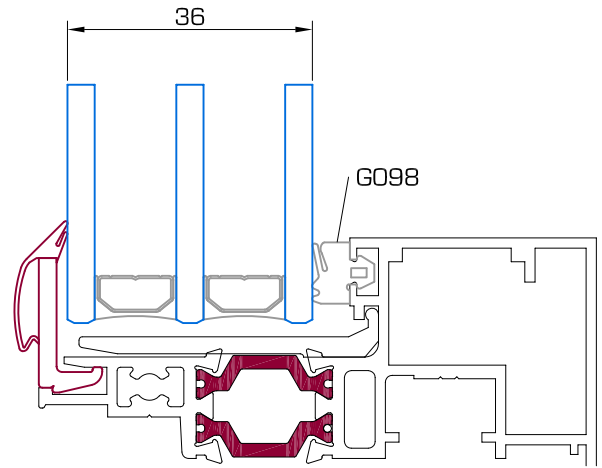
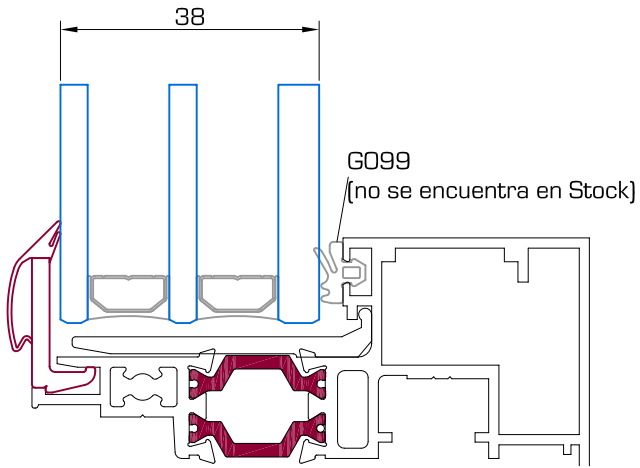

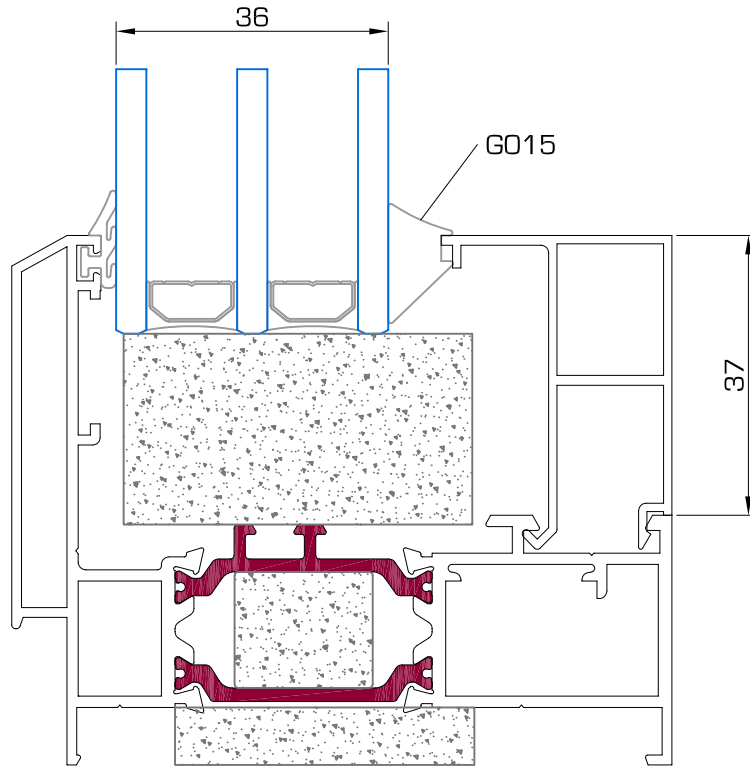

6074 Junquillo 30,5 mm H.O.

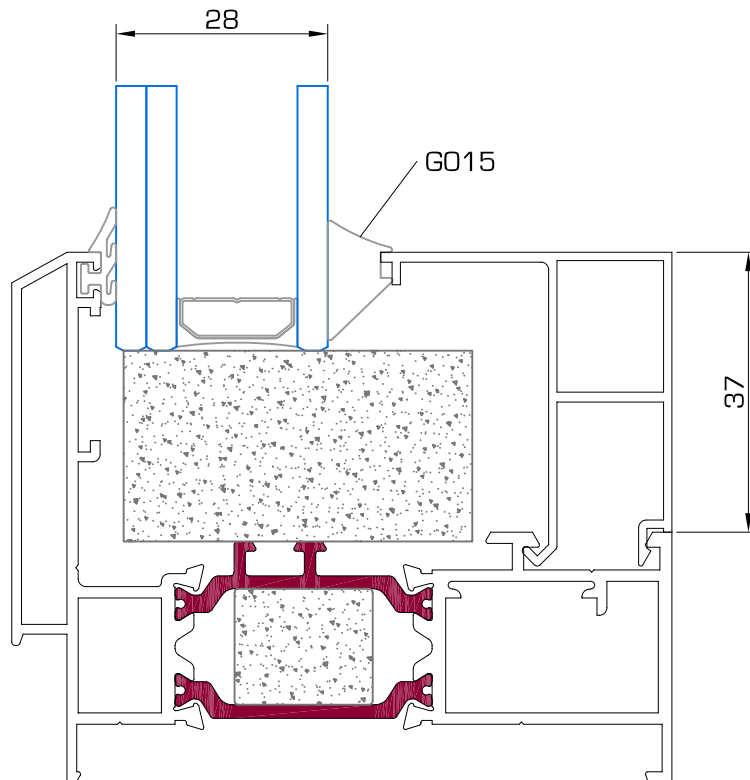

6073 Junquillo 38,5 mm H.O.

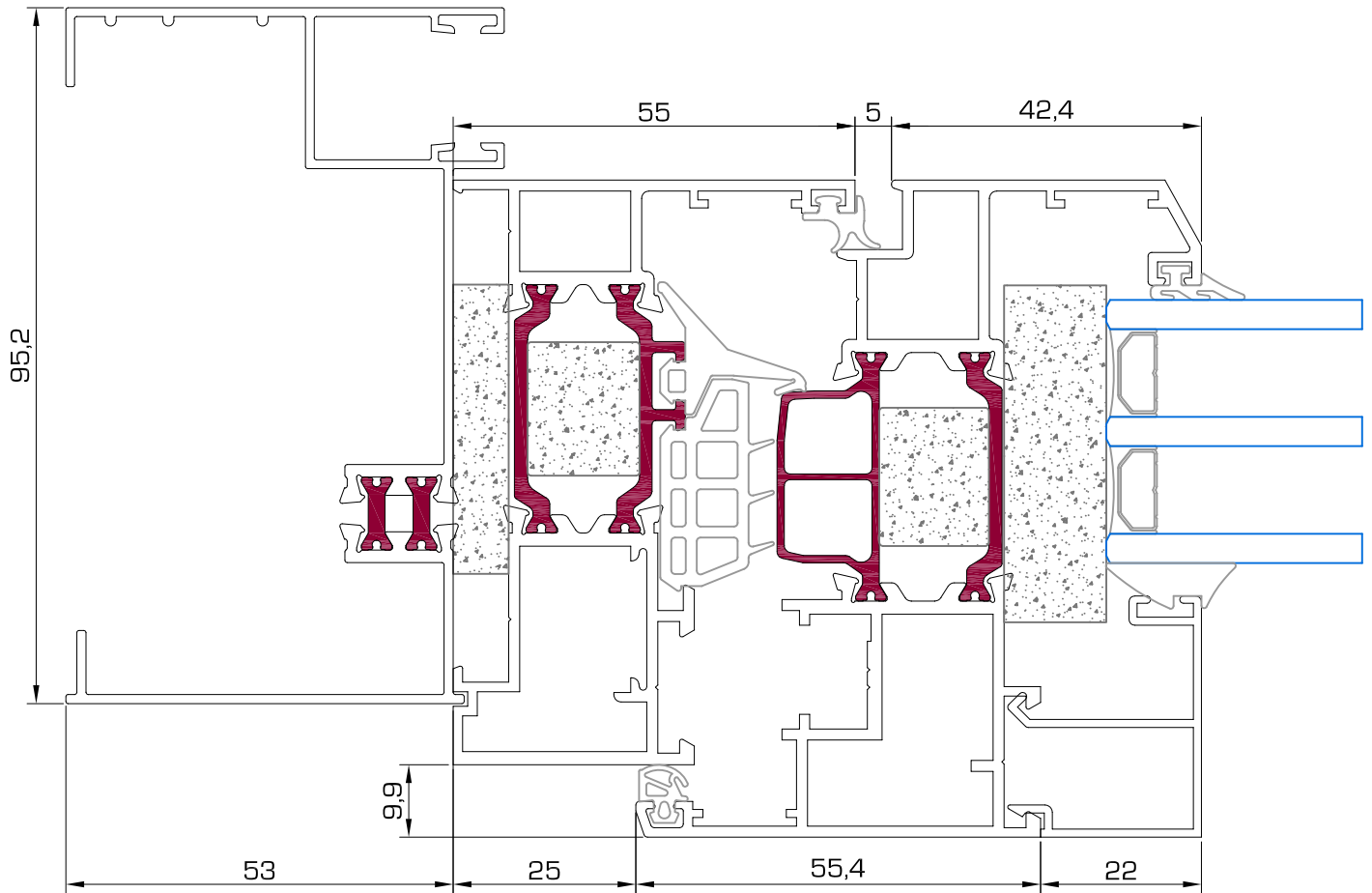
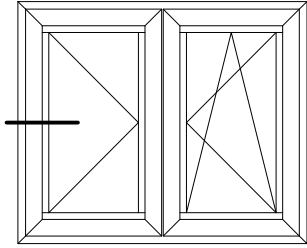

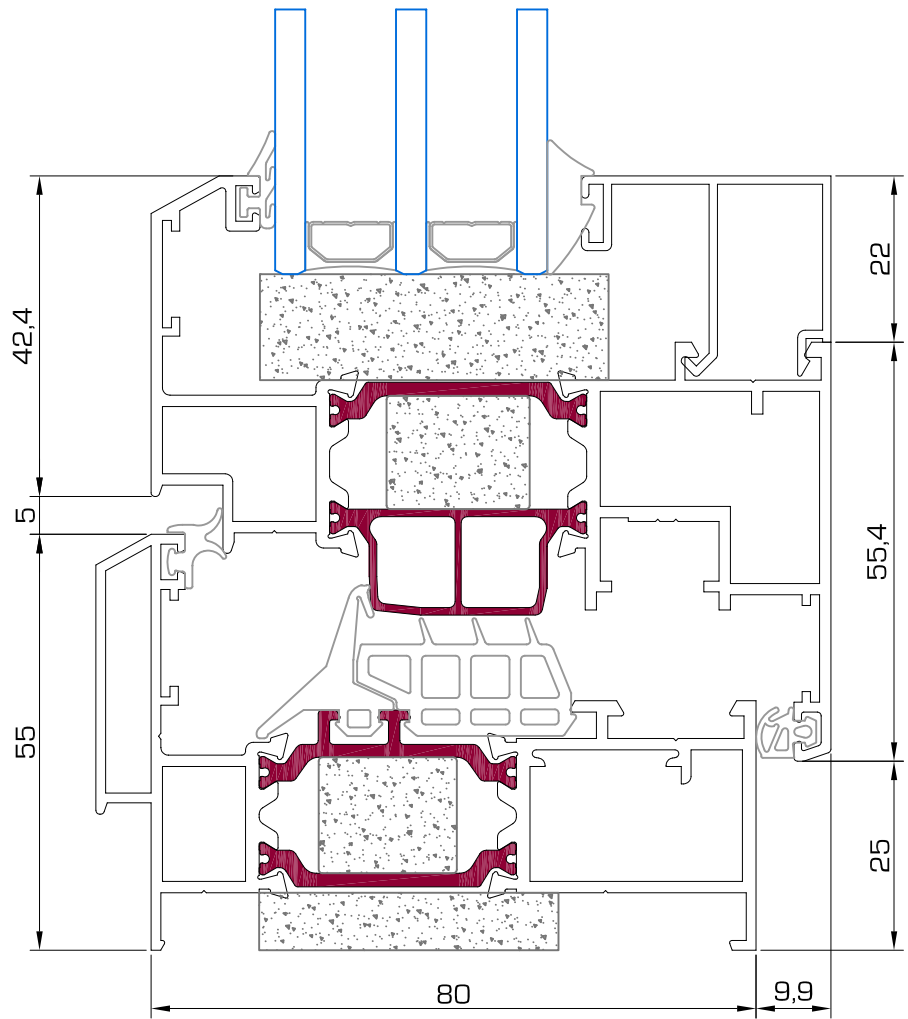
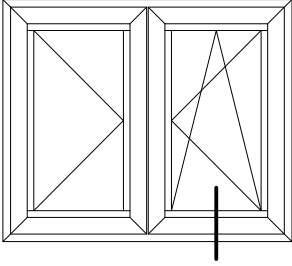

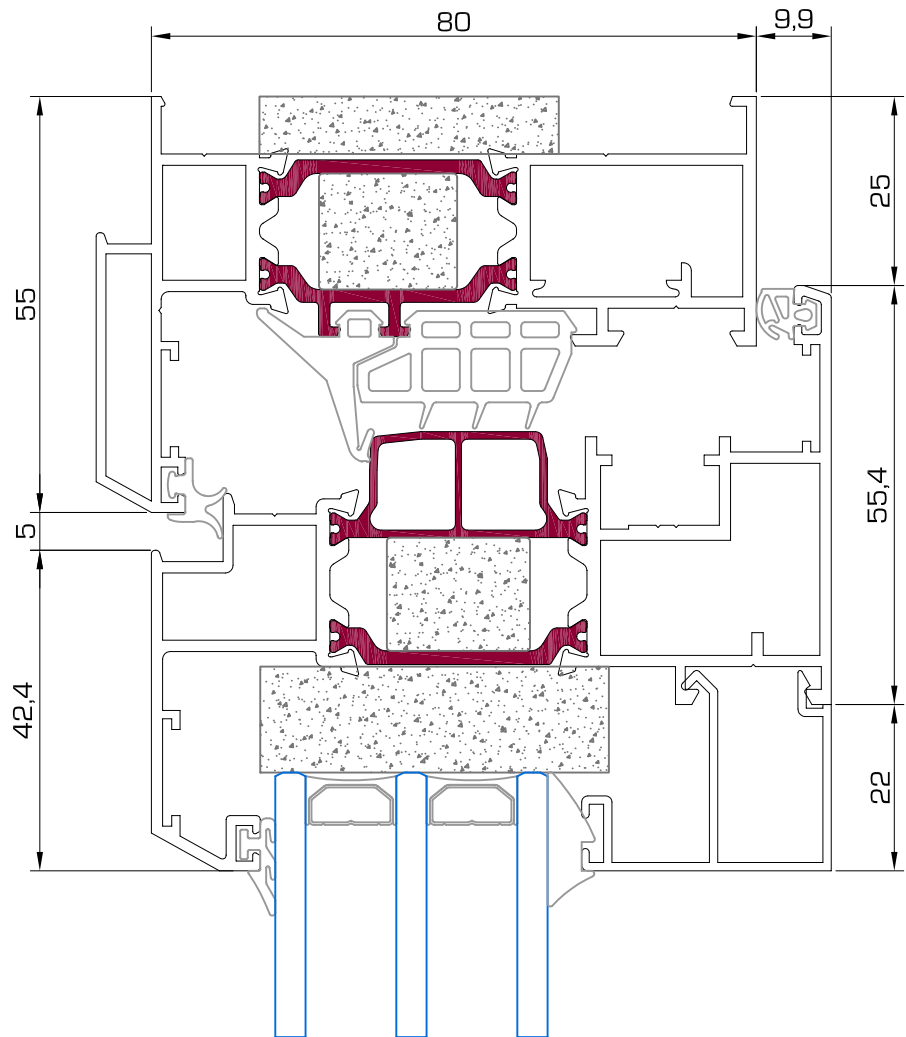
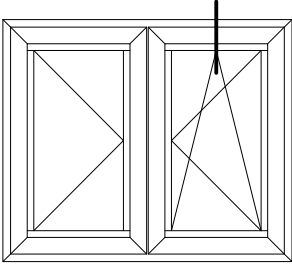

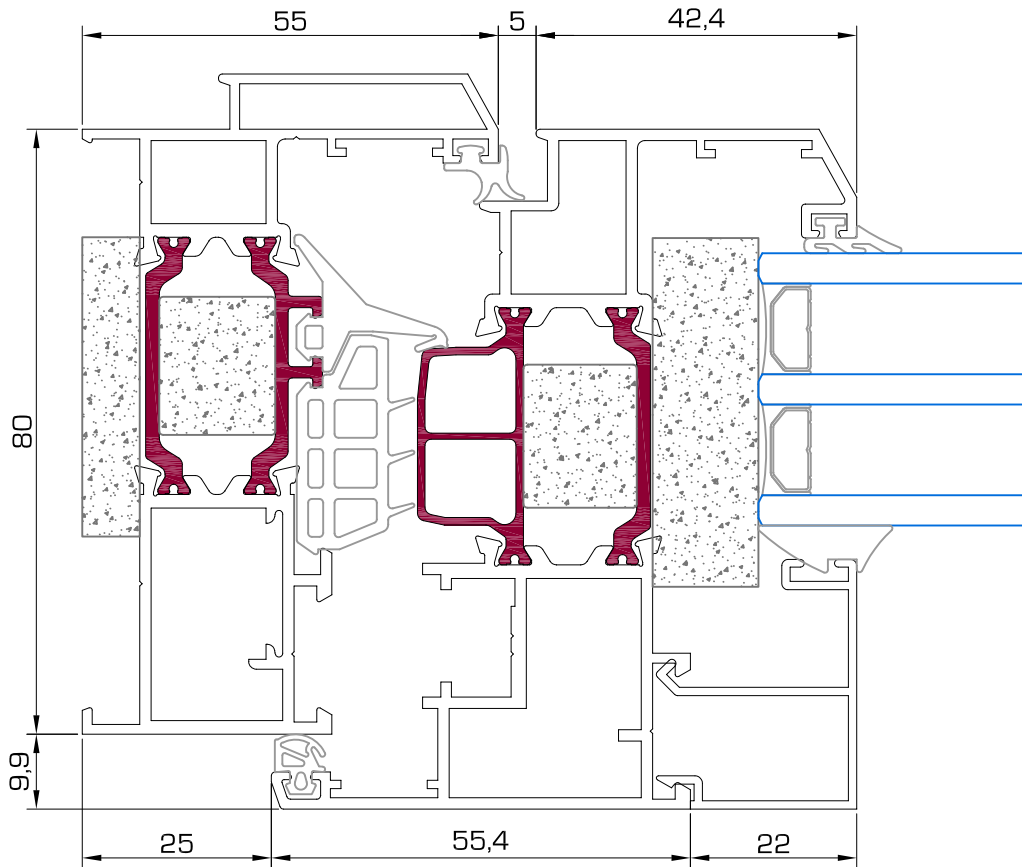
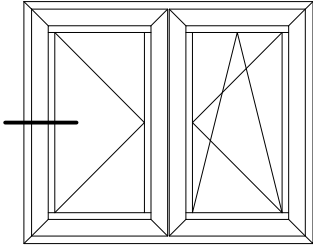

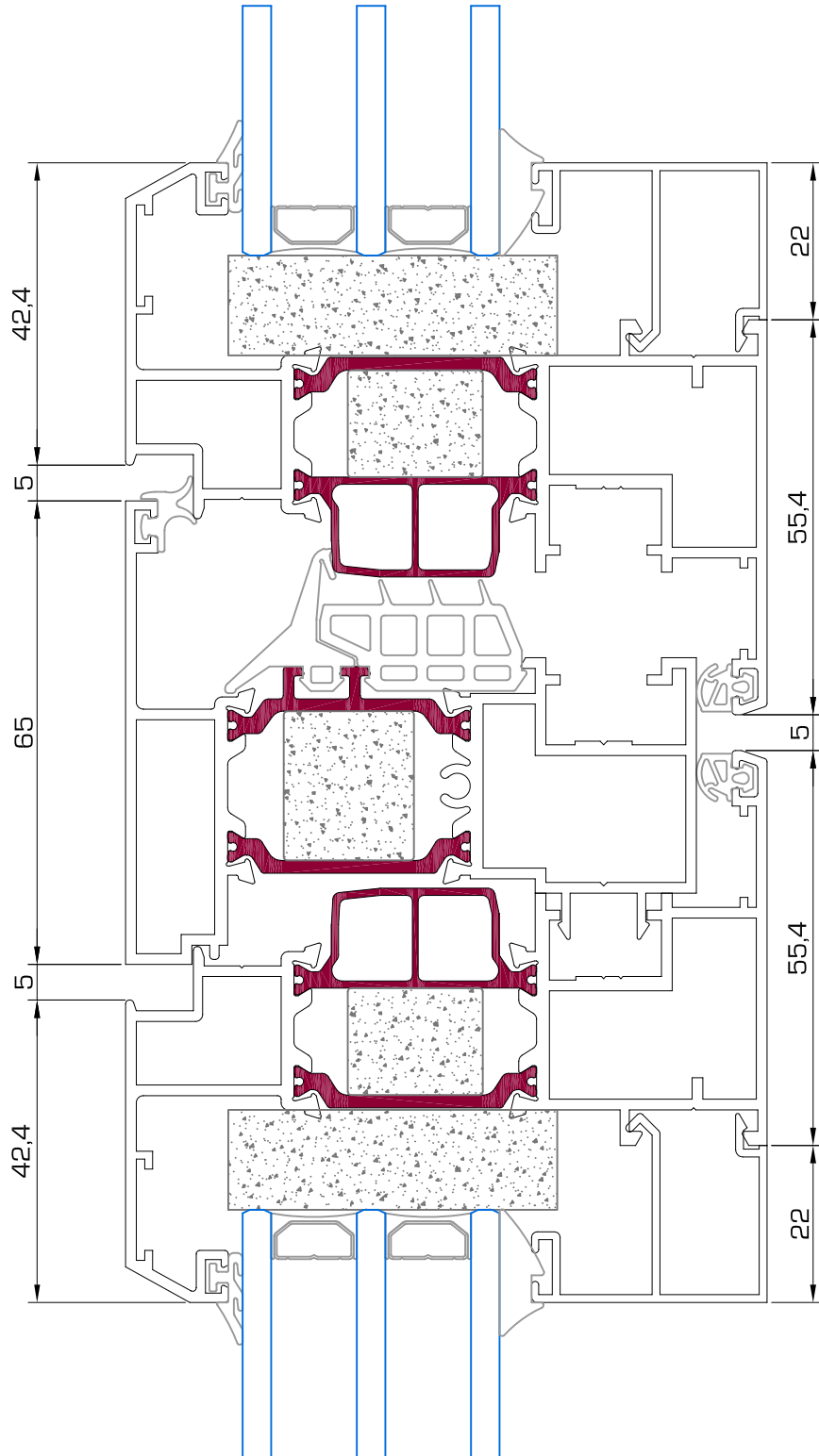
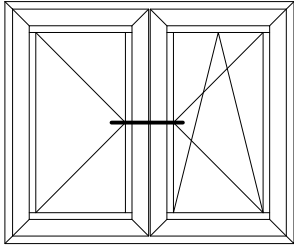

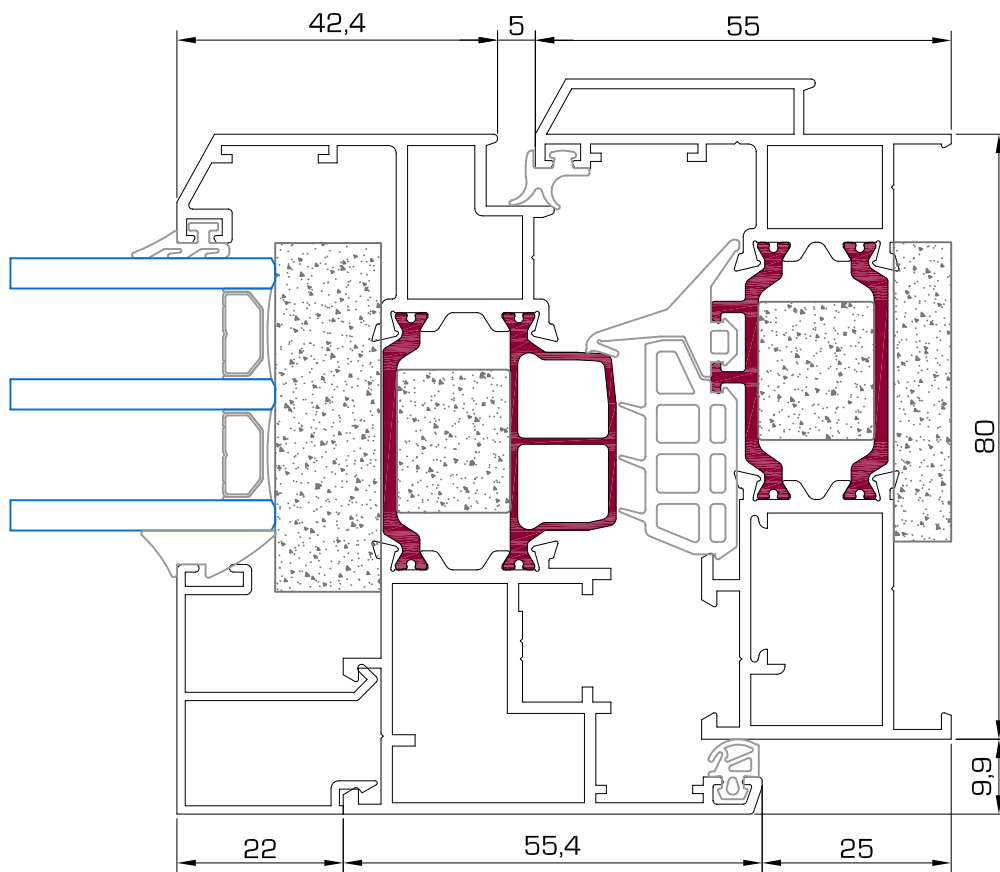
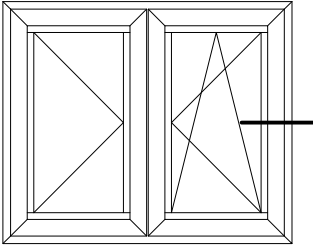

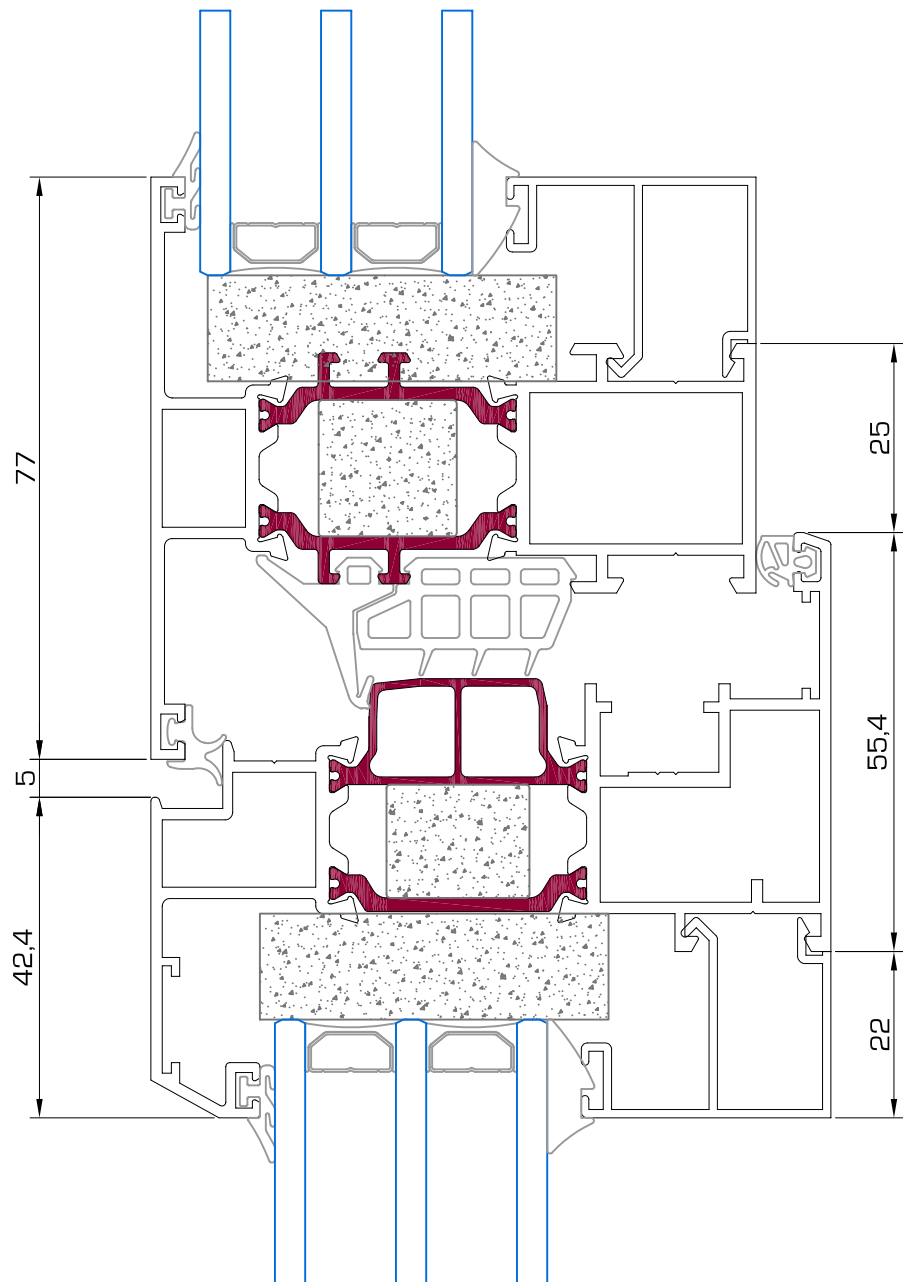
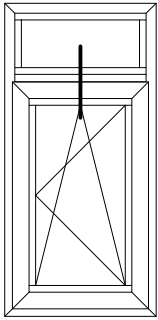

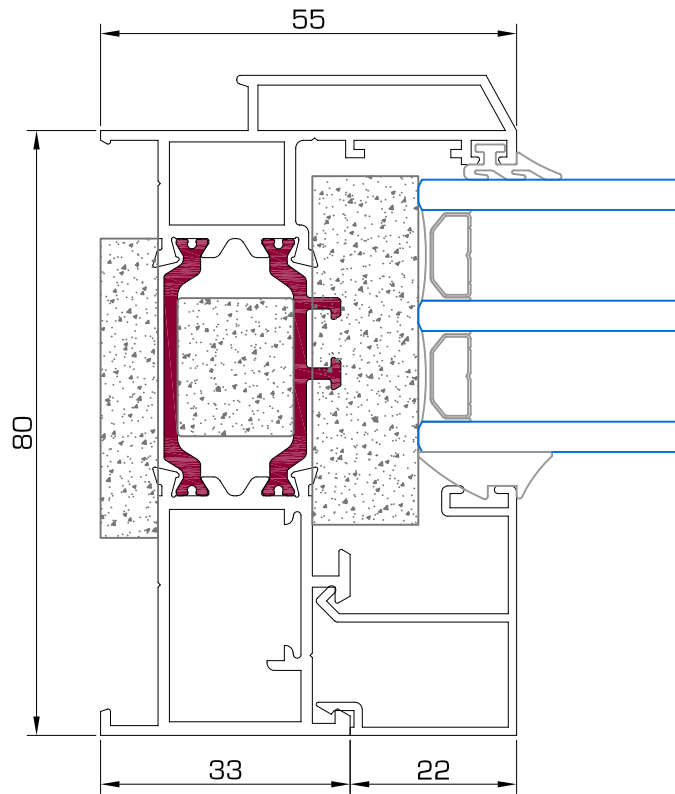
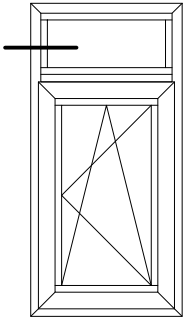

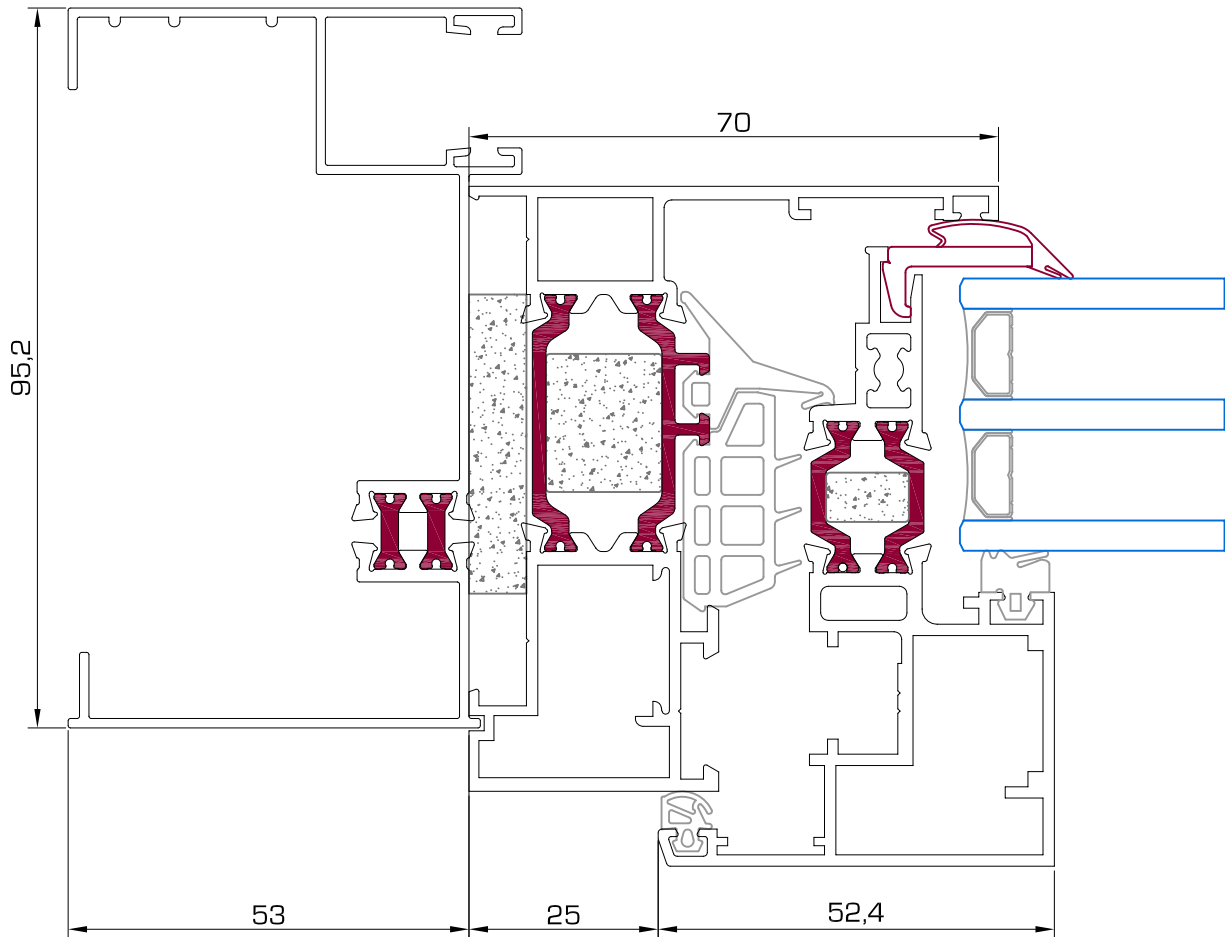
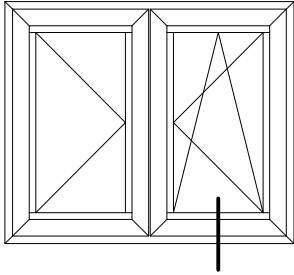

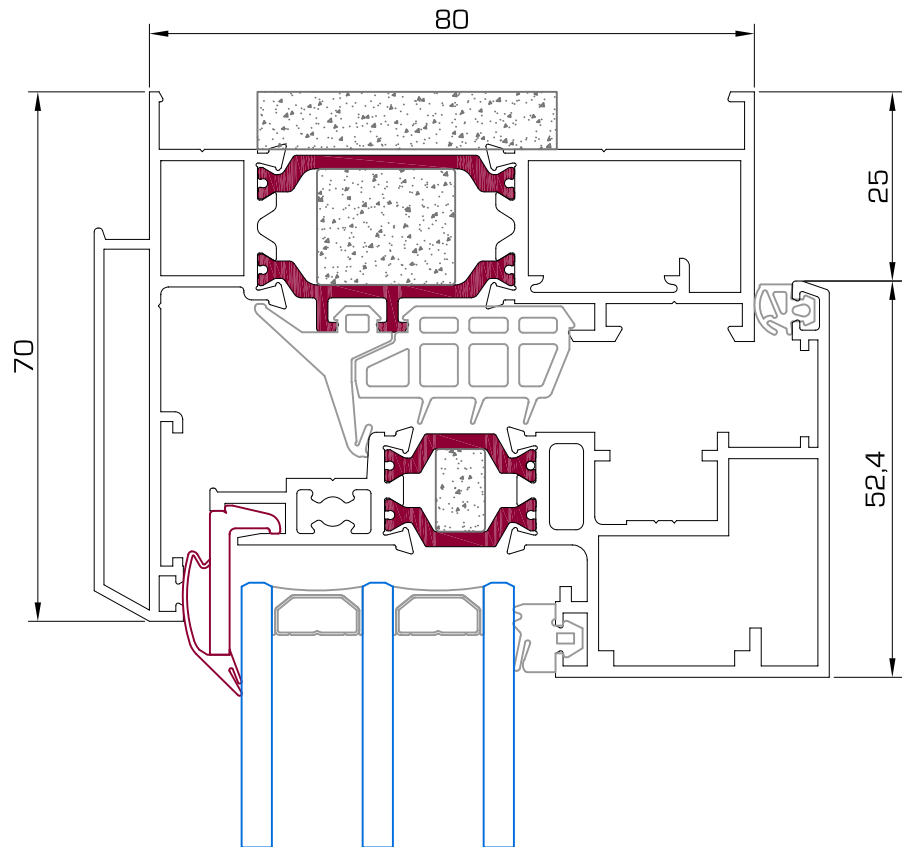
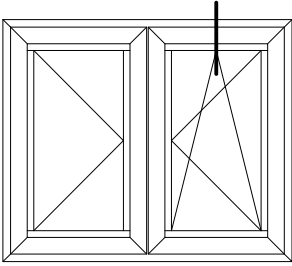

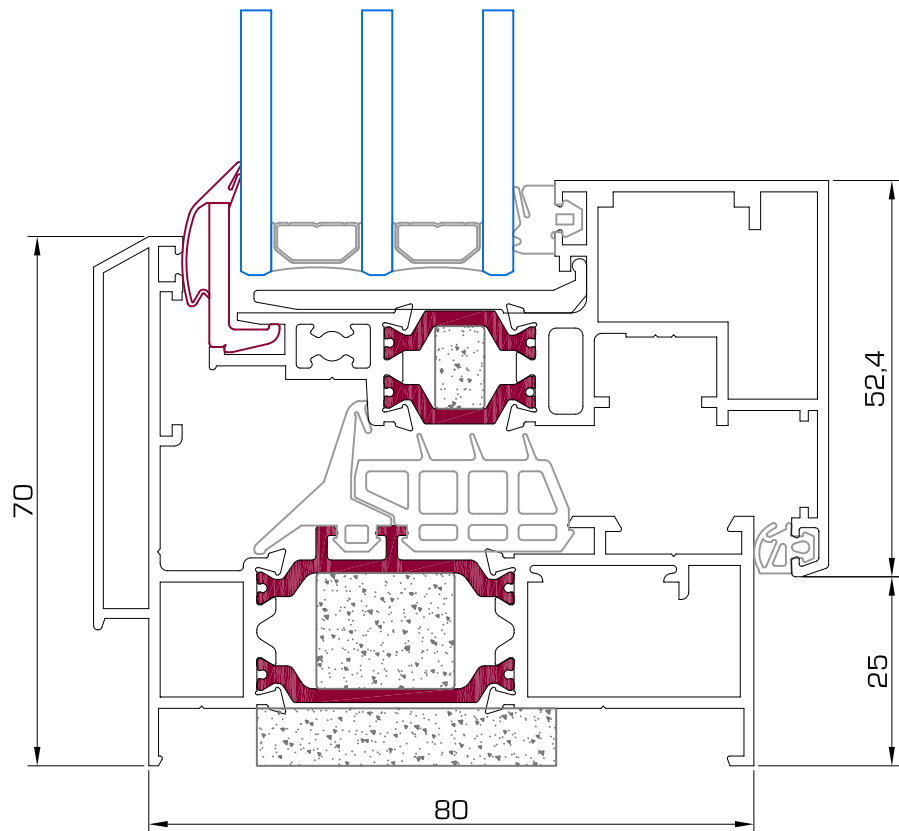
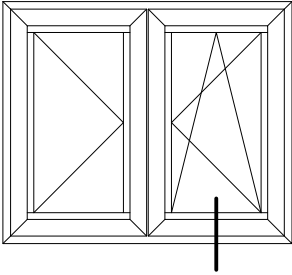

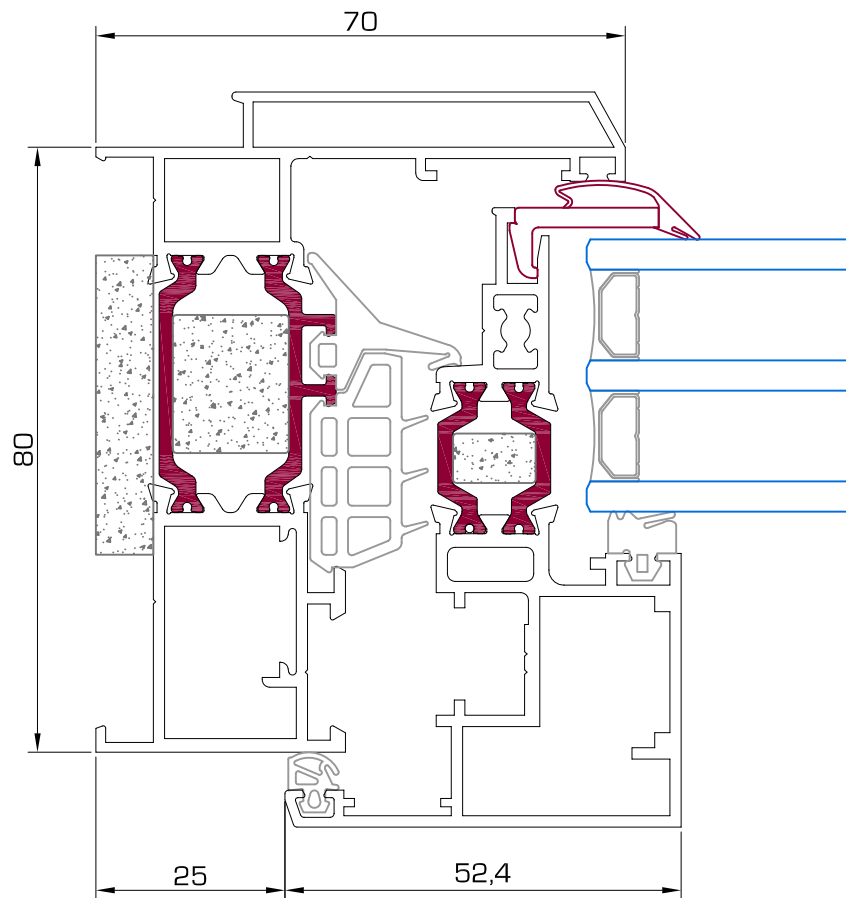
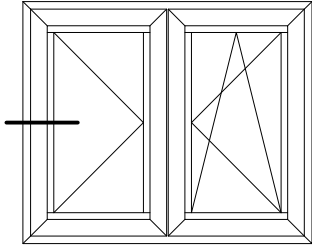

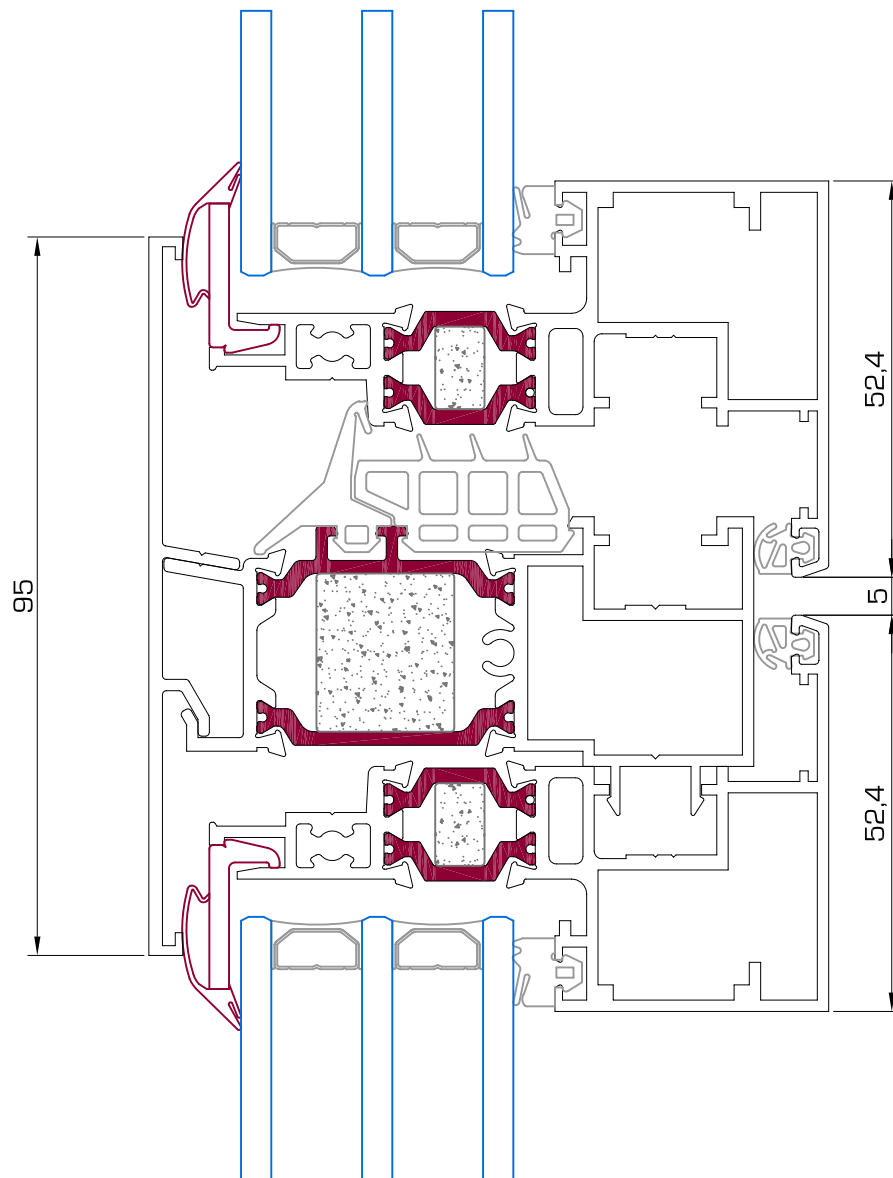
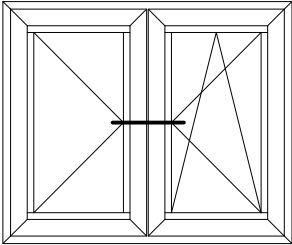

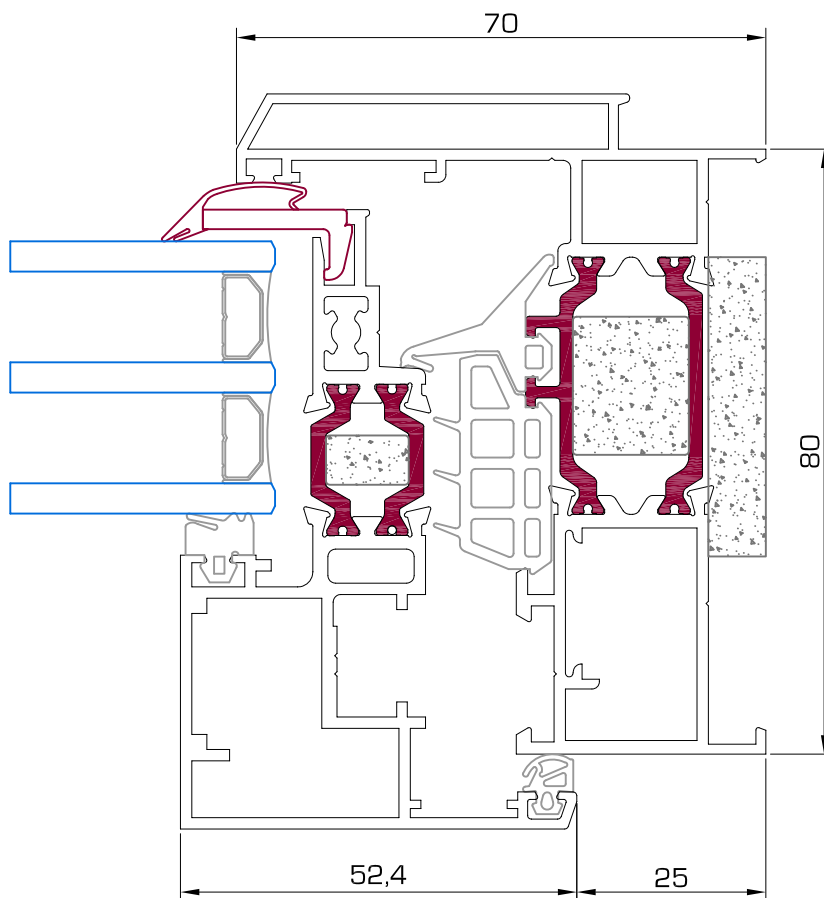
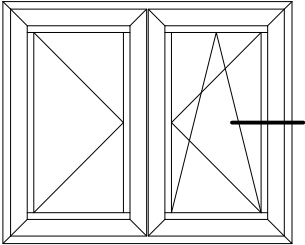

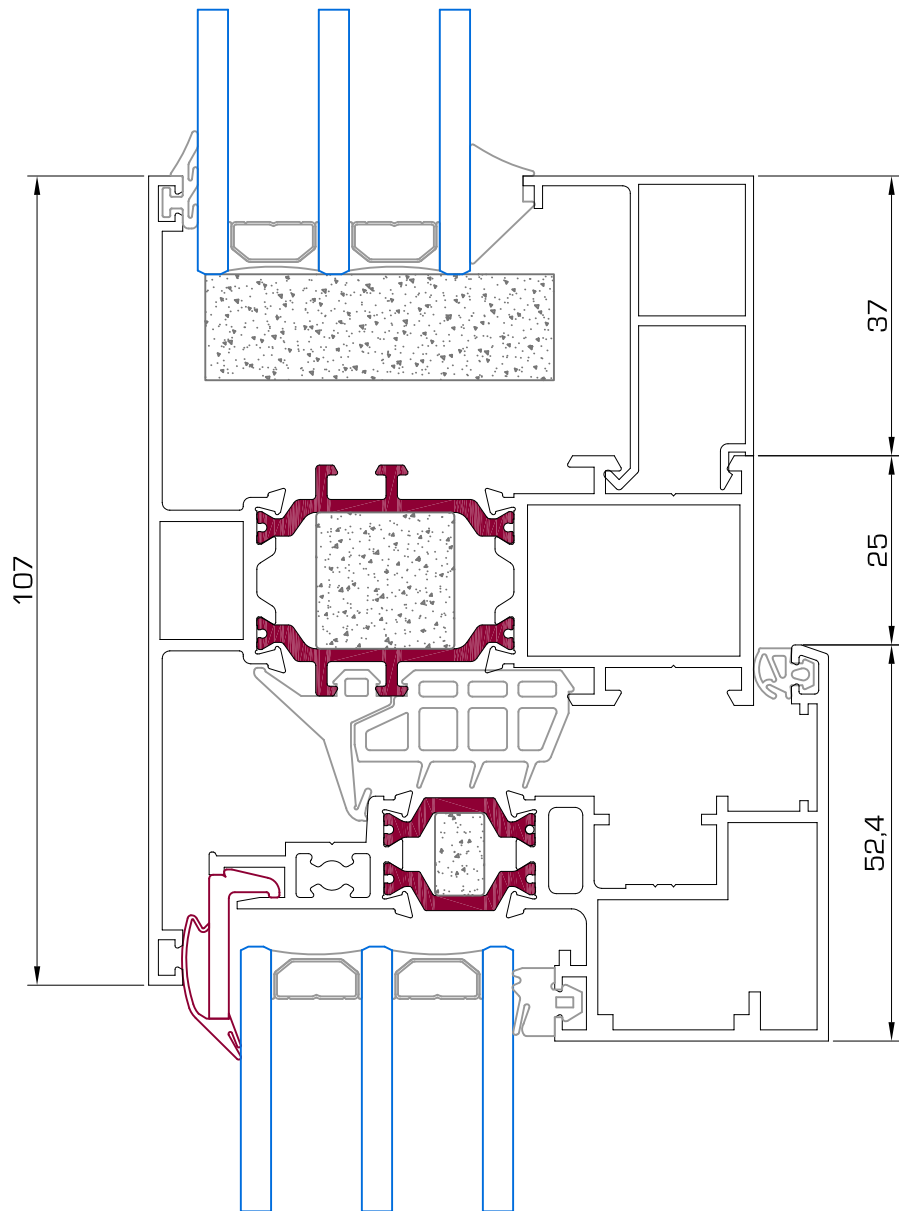
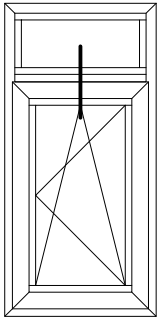

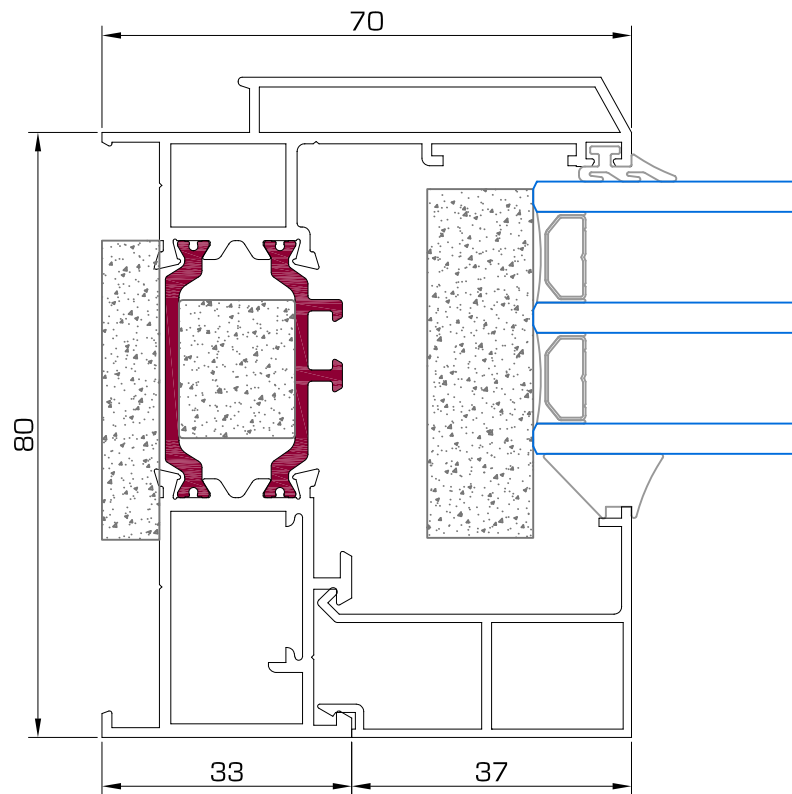
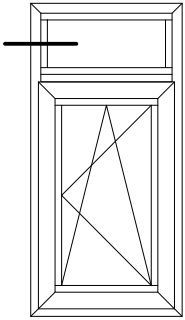



COLOCACIÓN ACCESORIOS

Accesorios Marco ventana Ref.6000		
1	G069	Goma batiente exterior marco
2	G090	Goma junta central
3	G091	Goma junta central refuerzo térmico
4	E080	Escuadra ventana interior
5	E081	Escuadra ventana exterior
6	F080	Espuma térmica

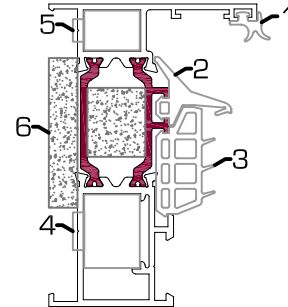

Accesorios Marco ventana Ref.6006		
1	G069	Goma batiente exterior marco
2	G090	Goma junta central
3	G091	Goma junta central refuerzo térmico
4	E080	Escuadra ventana interior
5	E081	Escuadra ventana exterior
6	F080	Espuma térmica

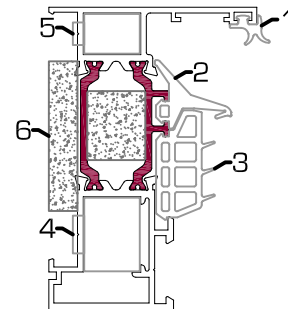

Accesorios Marco ventana Ref.6007		
1	G069	Goma batiente exterior marco
2	G090	Goma junta central
3	G091	Goma junta central refuerzo térmico
4	E080	Escuadra ventana interior
5	E081	Escuadra ventana exterior
6	F080	Espuma térmica

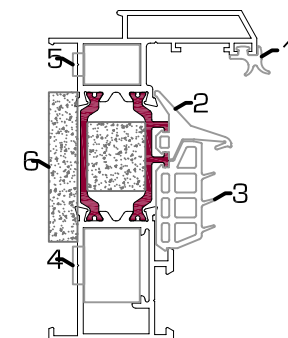

Accesorios Marco ventana Ref.6020		
1	G069	Goma batiente exterior marco
2	G090	Goma junta central
3	G091	Goma junta central refuerzo térmico
4	E084	Escuadra ventana interior
5	E085	Escuadra ventana exterior
6	F080	Espuma térmica

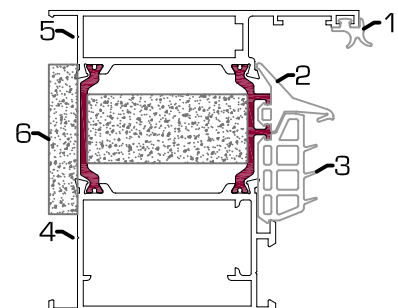



COLOCACIÓN ACCESORIOS

Accesorios Marco ventana Ref.6001		
1	G077	Goma exterior para acristalado
2	G049	Goma batiente hoja
3	E080	Escuadra ventana interior
4	E081	Escuadra ventana exterior
5	F081	Espuma térmica galce vidrio
6	E031	Escuadra de alineamiento

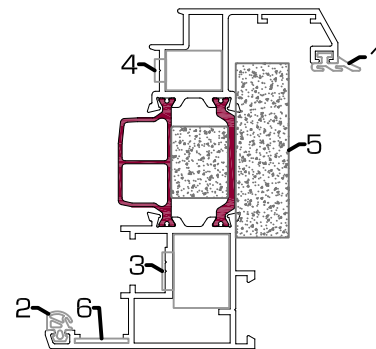

Accesorios Marco ventana Ref.6021		
1	G077	Goma exterior para acristalado
2	G049	Goma batiente hoja
3	E084	Escuadra puerta interior
4	E085	Escuadra puerta exterior
5	F081	Espuma térmica galce vidrio
6	E031	Escuadra de alineamiento

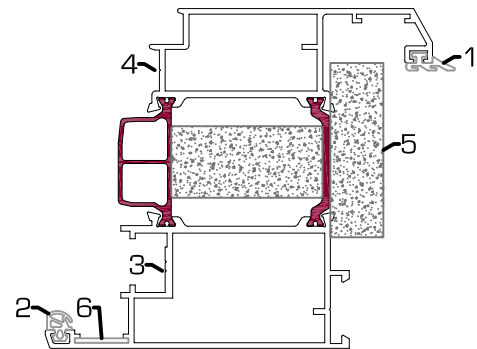

Accesorios Marco ventana Ref.6028		
1	G077	Goma exterior para acristalado
2	G049	Goma batiente hoja
3	E084	Escuadra puerta interior
4	E085	Escuadra puerta exterior
5	F081	Espuma térmica galce vidrio
6	E031	Escuadra de alineamiento

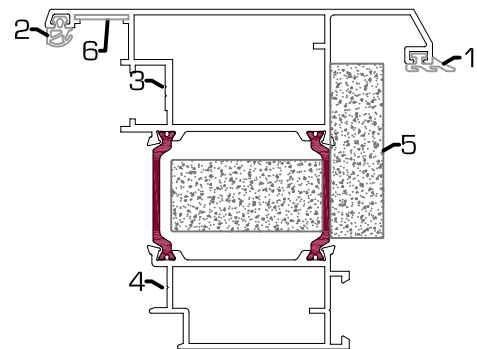



Accesorios Marco ventana Ref.6002		
1	G069	Goma batiente exterior marco
2	G090	Goma junta central
3	G091	Goma junta central refuerzo térmico
4	K080	Juego tapones de inversor

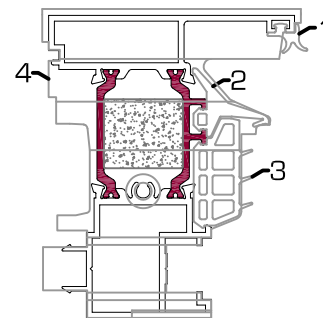

Accesorios Marco ventana Ref.6004		
1	G069	Goma batiente exterior marco
2	G090	Goma junta central
3	G091	Goma junta central refuerzo térmico
4	U008	Tope unión de travesaño ventana
5	G077	Goma exterior para acristalado
6	F081	Espuma térmica galce vidrio

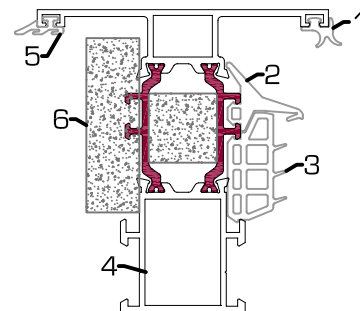

Accesorios Marco ventana Ref.6024		
1	G069	Goma batiente exterior marco
2	G090	Goma junta central
3	G091	Goma junta central refuerzo térmico
4	U009	Tope unión de travesaño puerta
5	G077	Goma exterior para acristalado
6	F081	Espuma térmica galce vidrio

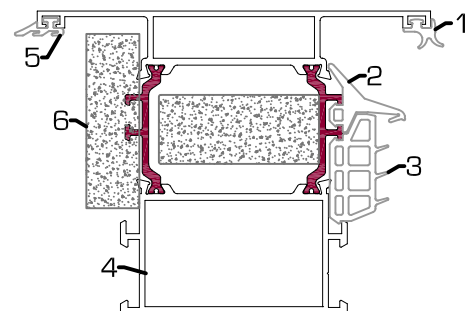



COLOCACIÓN ACCESORIOS

Accesorios Marco ventana Ref.6050		
1	G090	Goma junta central
2	G091	Goma junta central refuerzo térmico
3	E080	Escuadra ventana interior
4	E081	Escuadra ventana exterior
5	E090	Escuadra Fuji
6	F080	Espuma térmica

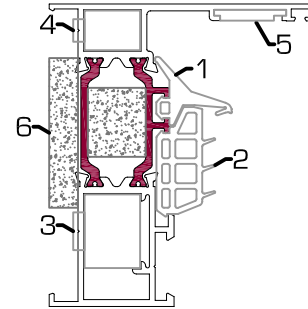

Accesorios Marco ventana Ref.6056		
1	G090	Goma junta central
2	G091	Goma junta central refuerzo térmico
3	E080	Escuadra ventana interior
4	E081	Escuadra ventana exterior
5	E090	Escuadra Fuji
6	F080	Espuma térmica

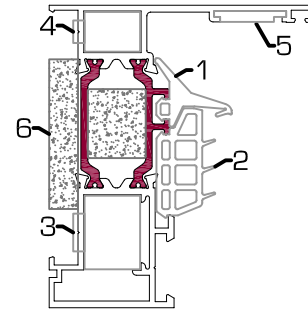

Accesorios Marco ventana Ref.6057		
1	G090	Goma junta central
2	G091	Goma junta central refuerzo térmico
3	E080	Escuadra ventana interior
4	E081	Escuadra ventana exterior
5	E090	Escuadra Fuji
6	F080	Espuma térmica

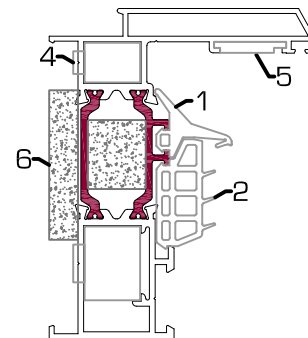

Accesorios Marco ventana Ref.6052		
1	G090	Goma junta central
2	G091	Goma junta central refuerzo térmico
3	K081	Juego tapones de inversor H.O.

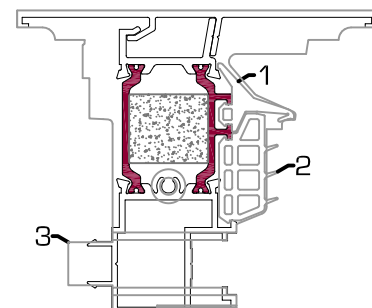



COLOCACIÓN ACCESORIOS

Accesorios Marco ventana Ref.6051		
1	U080	Junquillo PVC hoja oculta
2	Ver acristalamiento	Goma acristalar
3	G049	Goma batiente hoja
4	E080	Escuadra ventana interior
5	E031	Escuadra de alineamiento

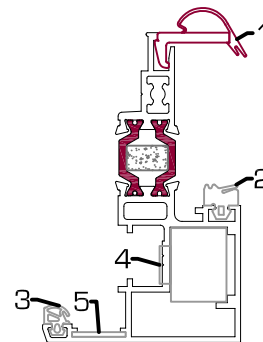

Accesorios Marco ventana Ref.6054		
1	G090	Goma junta central
2	G091	Goma junta central refuerzo térmico
3	U008	Tope unión de travesaño ventana
4	G077	Goma exterior para acristalado
5	F081	Espuma térmica galce vidrio

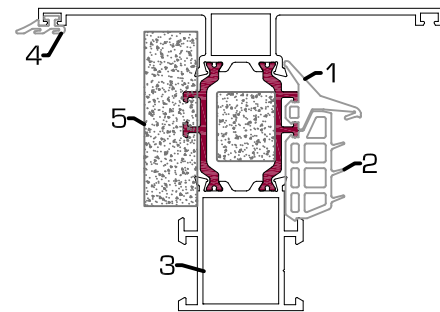

Accesorios Marco ventana Ref.6064		
1	G090	Goma junta central
2	G091	Goma junta central refuerzo térmico
3	U009	Tope unión de travesaño puerta
4	G077	Goma exterior para acristalado
5	F081	Espuma térmica galce vidrio

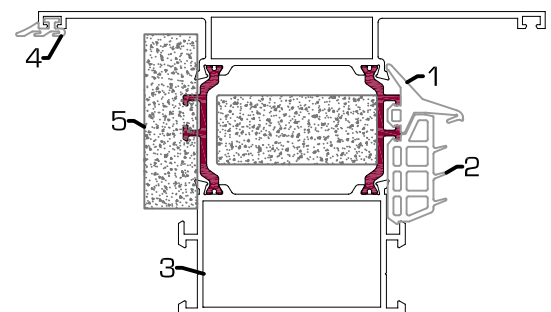

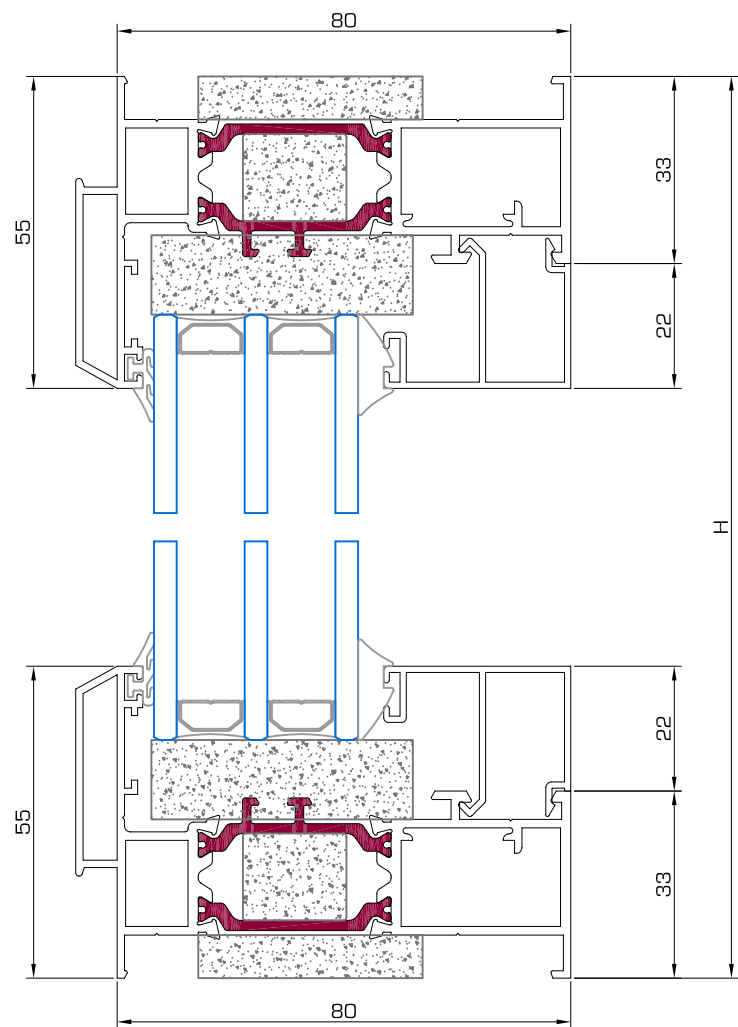

Ref.	Dibujo	Descripción	Corte	Uds.	Descuento
6000		Marco horizontal		2	L
6006		Marco vertical		2	H
Junquillos Clip		Junquillo horizontal		2	L - 66
		Junquillo vertical		2	H - 110
Junquillos Grapa		Junquillo horizontal		2	L - 66
		Junquillo vertical		2	H - 66

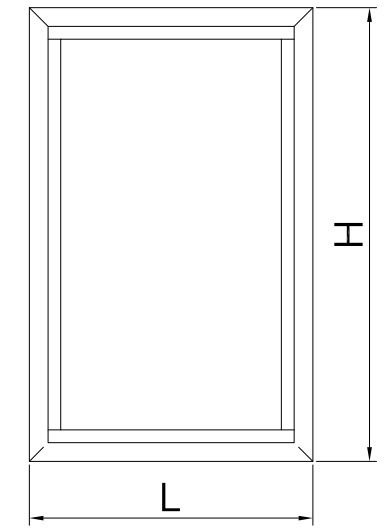
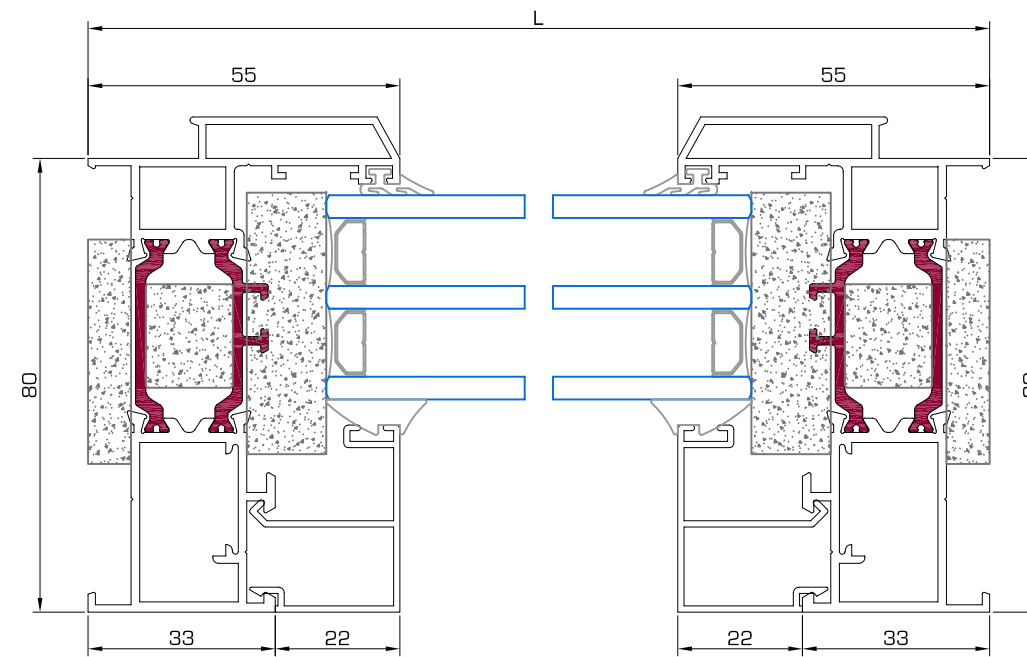

SECCIÓN VENTANA 1 HOJA

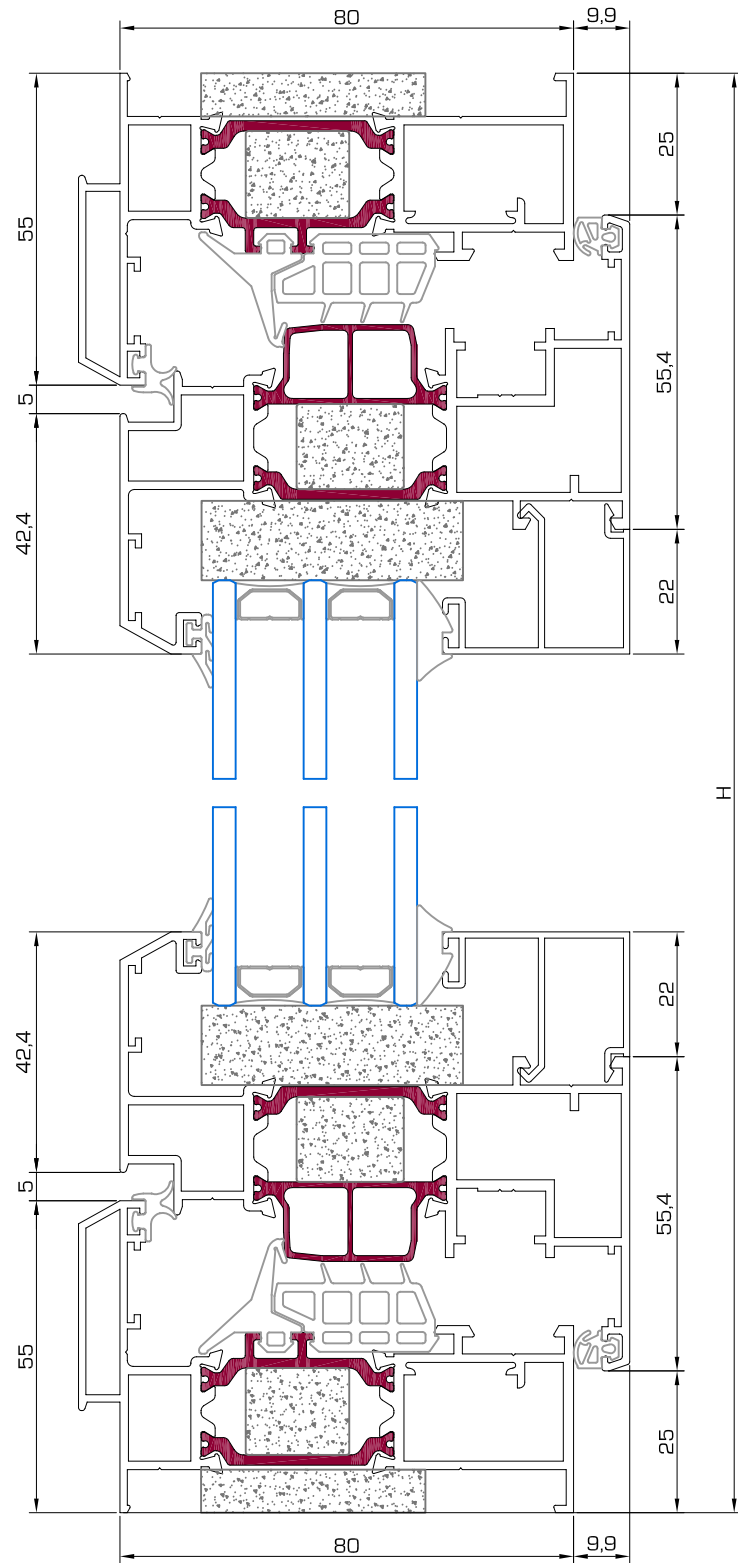

Ref.	Dibujo	Descripción	Corte	Uds.	Descuento
6000 6006 6007		Marco horizontal		2	L
		Marco vertical		2	H
6001		Hoja horizontal		2	L - 50
		Hoja vertical		2	H - 50
Junquillos Clip		Junquillo horizontal		2	L - 160,8
		Junquillo vertical		2	H - 204,8
Junquillos Grapa		Junquillo horizontal		2	L - 160,8
		Junquillo vertical		2	H - 160,8

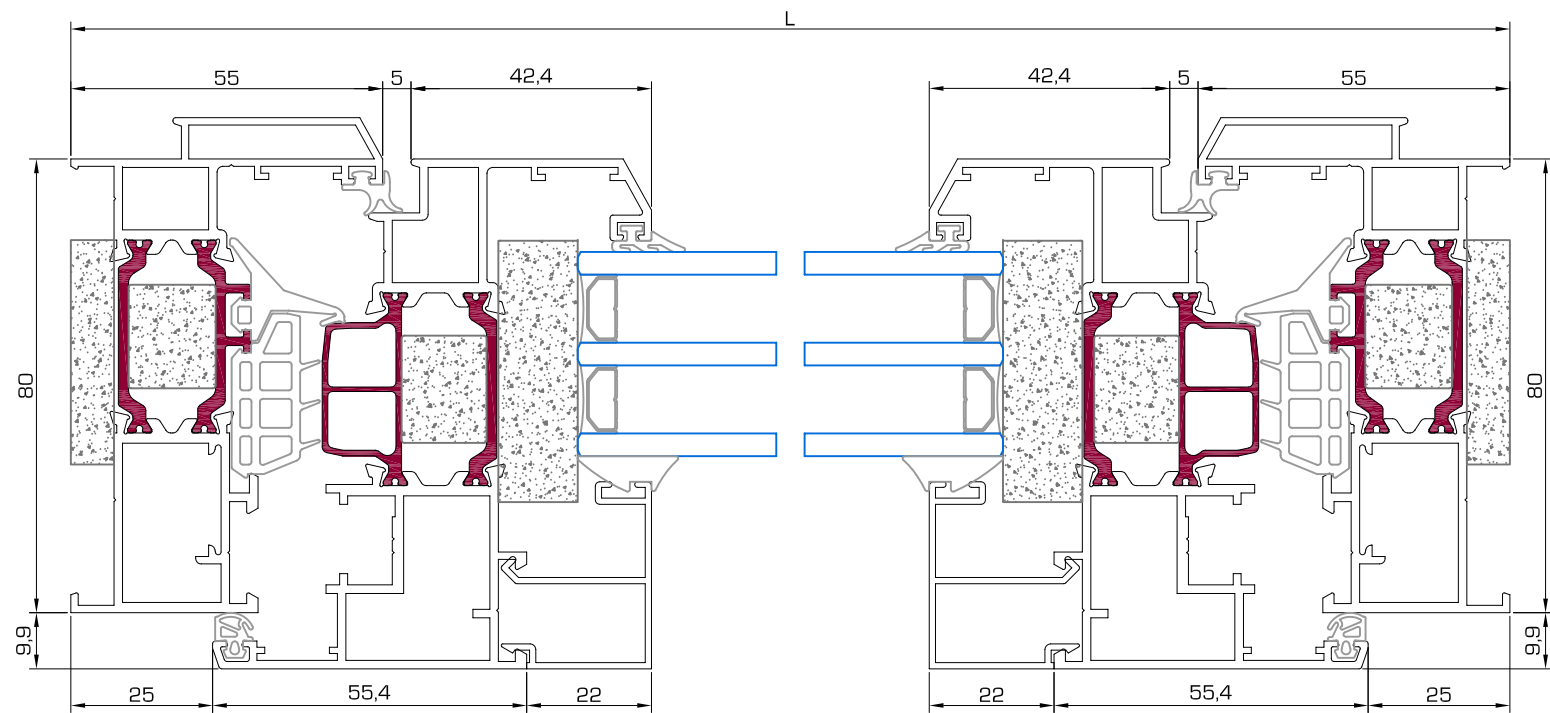
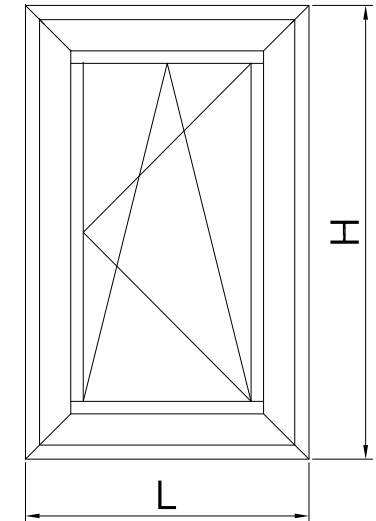

SECCIÓN VENTANA 2 HOJAS

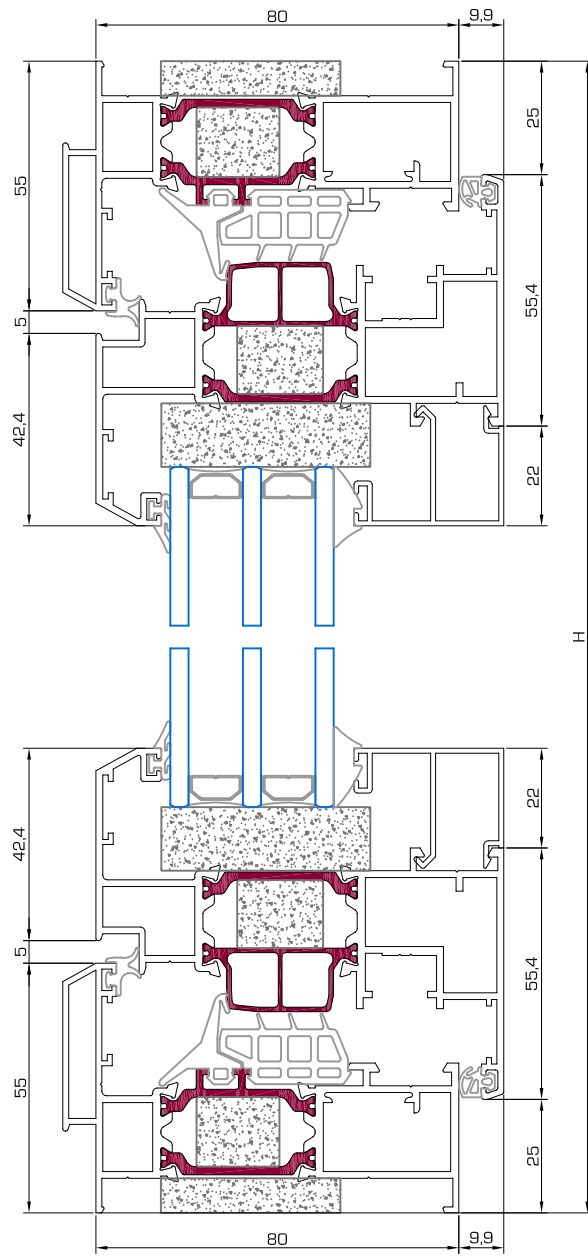

Ref.	Dibujo	Descripción	Corte	Uds.	Descuento
6000 6006 6007		Marco horizontal		2	L
		Marco vertical		2	H
6001		Hoja horizontal		4	(L - 55)/2
		Hoja vertical		4	H - 50
6002		Inversor		1	H - 127
Junquillos Clip		Junquillo horizontal Junquillo vertical		1	(L - 276,6)/2 H - 204,8
Junquillos Grapa		Junquillo horizontal Junquillo vertical		4	(L - 276,6)/2 H - 160,8

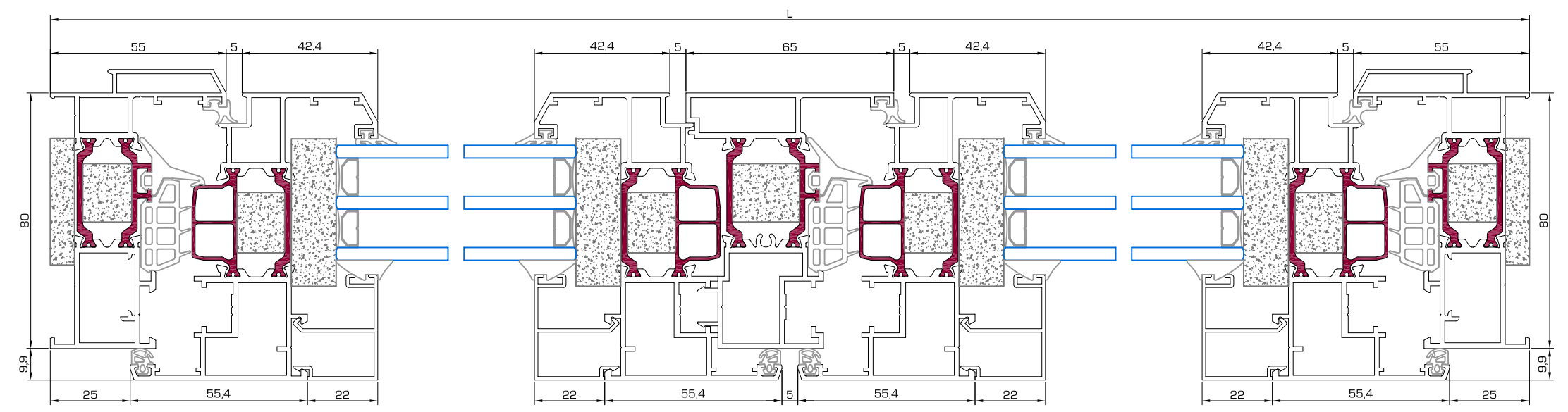
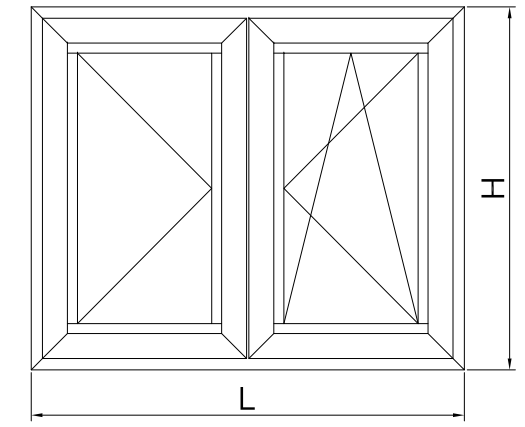

SECCIÓN VENTANA 1 HOJA CON FIJO

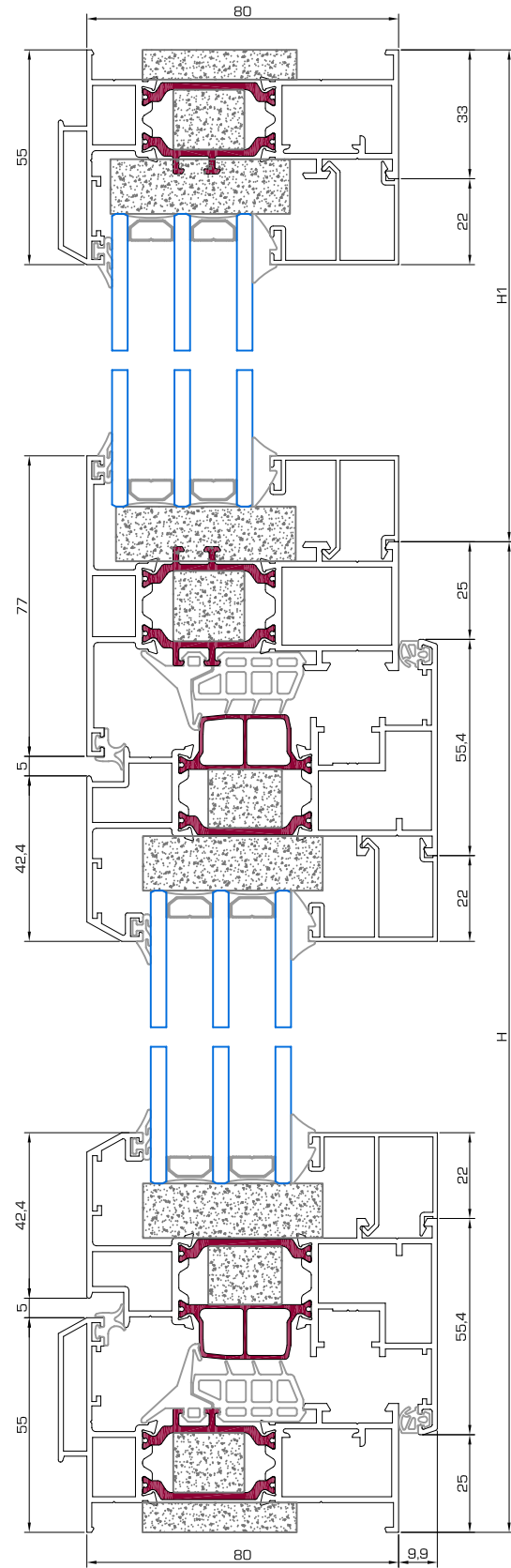

Ref.	Dibujo	Descripción	Corte	Uds.	Descuento
6000 6006 6007		Marco horizontal Marco vertical		2 2	L H
6001		Hoja horizontal Hoja vertical		2 2	L - 50 H - 50
6004		Travesaño		1	L - 56,6
Junquillos Clip (hojas)		Junquillo horizontal Junquillo vertical		2 2	L - 160,8 H - 204,8
Junquillos Grapa (hojas)		Junquillo horizontal Junquillo vertical		2 2	L - 160,8 H - 160,8
Junquillos Clip (fijo)		Junquillo horizontal Junquillo vertical		2 2	L - 66 H1 - 77
Junquillos Grapa (fijo)		Junquillo horizontal Junquillo vertical		2 2	L - 66 H1 - 33

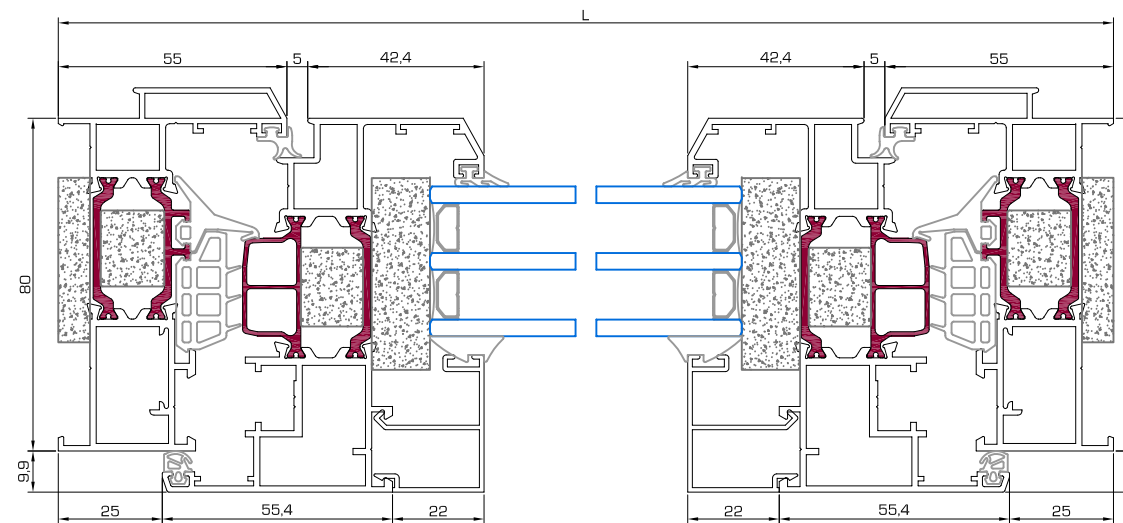
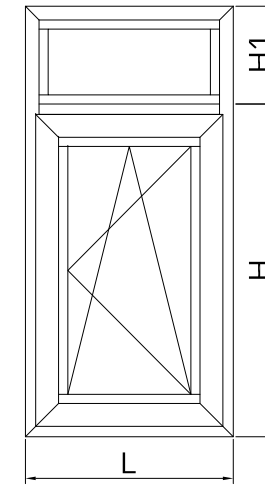

SECCIÓN VENTANA 2 HOJAS CON FIJO

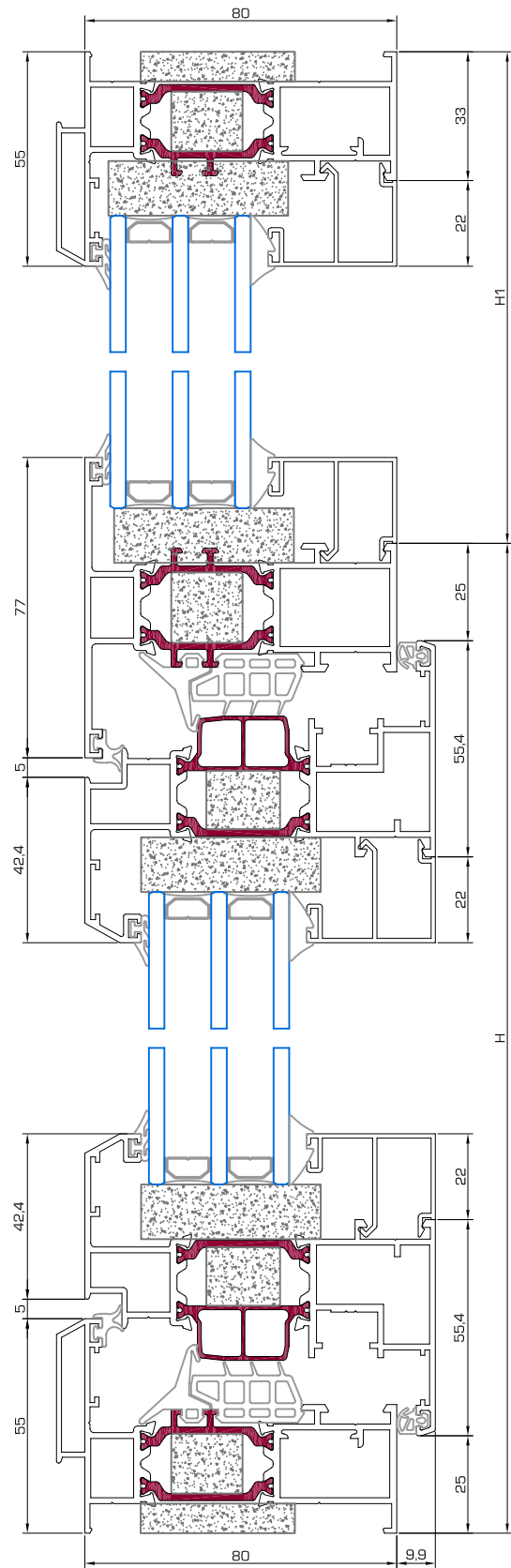

Ref.	Dibujo	Descripción	Corte	Uds.	Descuento
6000		Marco horizontal		2	L
6006		Marco vertical		2	H
6001		Hoja horizontal		4	(L - 55)/2
		Hoja vertical		4	H - 50
6002		Inversor		1	H - 127
6004		Travesaño		1	L - 56,6
Junquillos Clip (hojas)		Junquillo horizontal Junquillo vertical		4 4	(L - 276,6)/2 H - 204,8
Junquillos Grapa (hojas)		Junquillo horizontal Junquillo vertical		4 4	(L - 276,6)/2 H - 160,8
Junquillos Clip (fijo)		Junquillo horizontal Junquillo vertical		2 2	L - 66 H1 - 77
Junquillos Grapa (fijo)		Junquillo horizontal Junquillo vertical		2 2	L - 66 H1 - 33

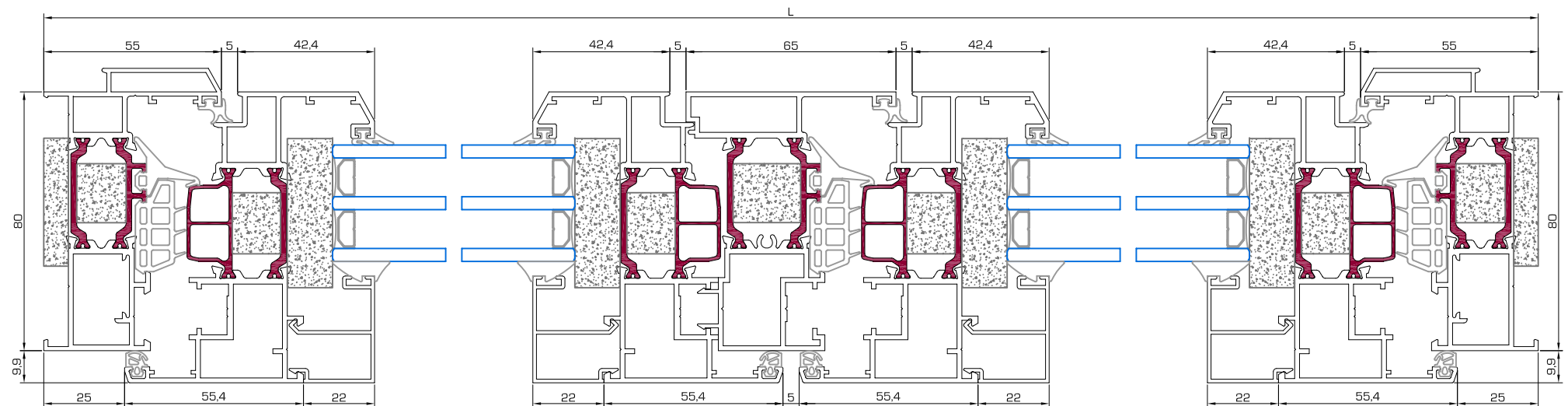
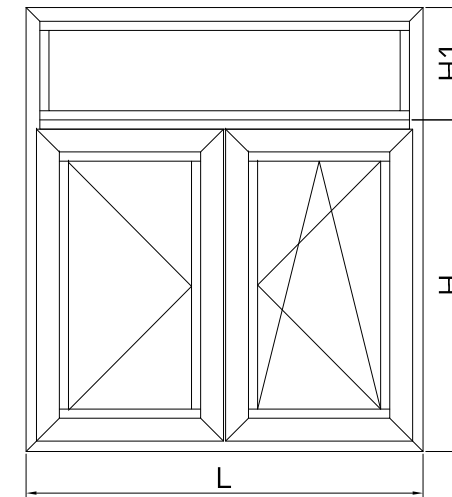

SECCIÓN FIJO MARCO PUERTA

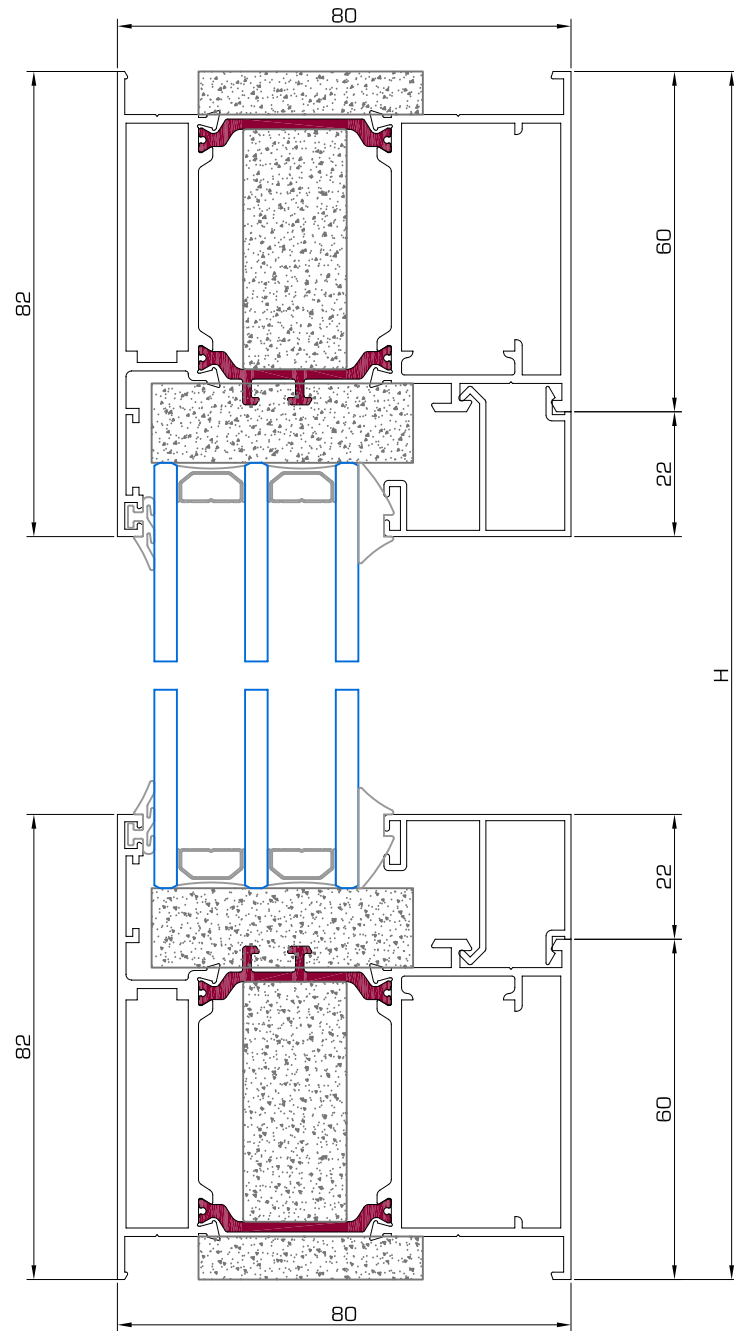

Ref.	Dibujo	Descripción	Corte	Uds.	Descuento
6020		Marco horizontal		2	L
		Marco vertical		2	H
Junquillos Clip		Junquillo horizontal		2	L - 120
		Junquillo vertical		2	H - 164
Junquillos Grapa		Junquillo horizontal		2	L - 120
		Junquillo vertical		2	H - 120

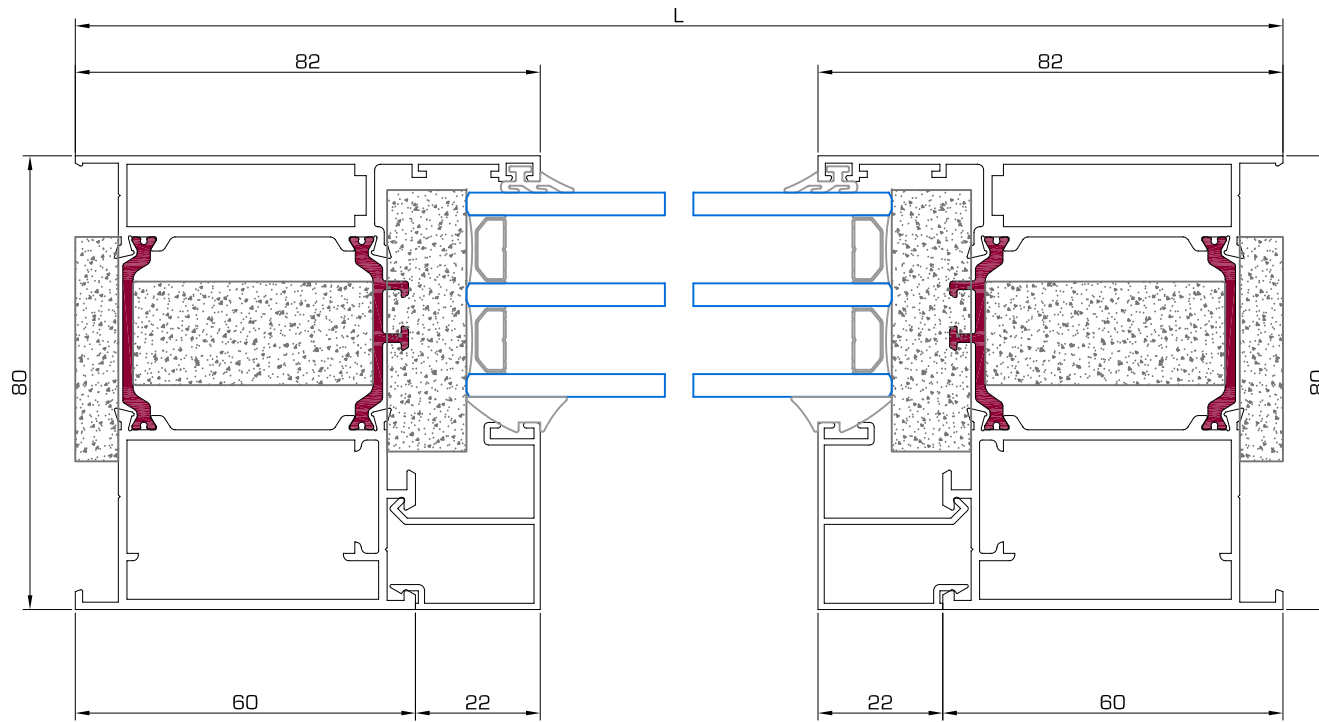
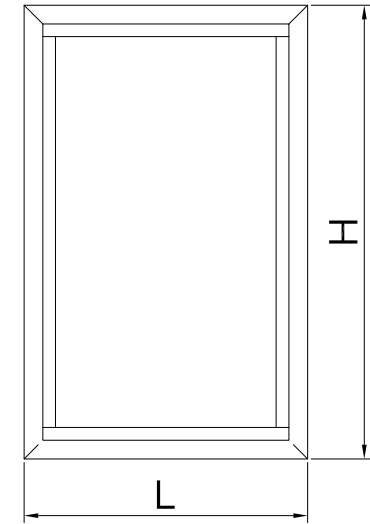

SECCIÓN PUERTA 1 HOJA

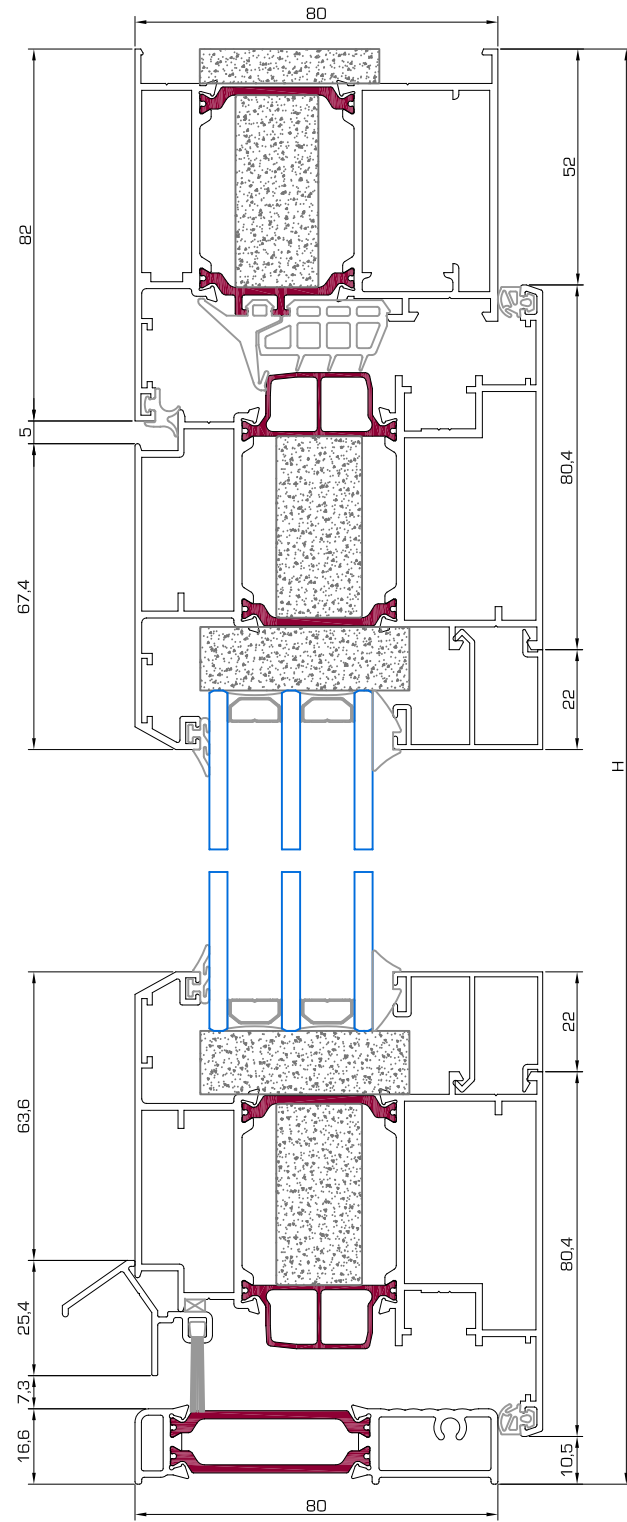

Ref.	Dibujo	Descripción	Corte	Uds.	Descuento
6020		Marco horizontal		1	L
		Marco vertical		2	H
6021		Hoja horizontal		2	L - 104
		Hoja vertical		2	H - 62,5
xxxx		Solera		1	L - 110,6
5051		Perfil remate		1	L - 177
Junquillos Clip		Junquillo horizontal		2	L - 264,8
		Junquillo vertical		2	H - 267,3
Junquillos Grapa		Junquillo horizontal		2	L - 264,8
		Junquillo vertical		2	H - 223,3

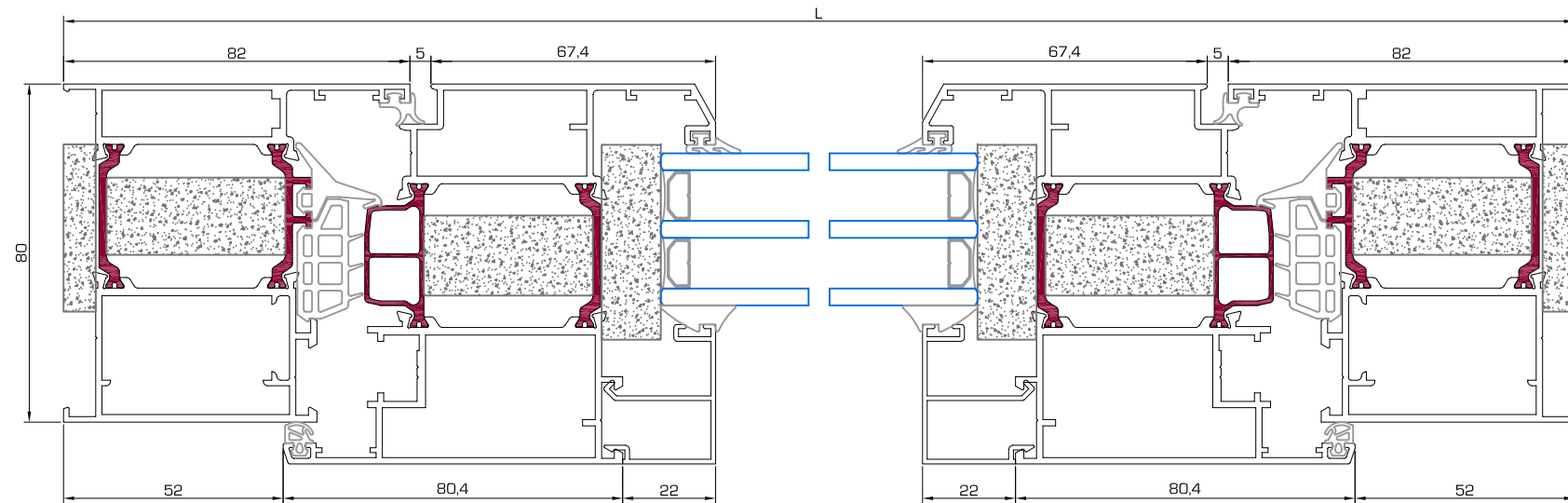
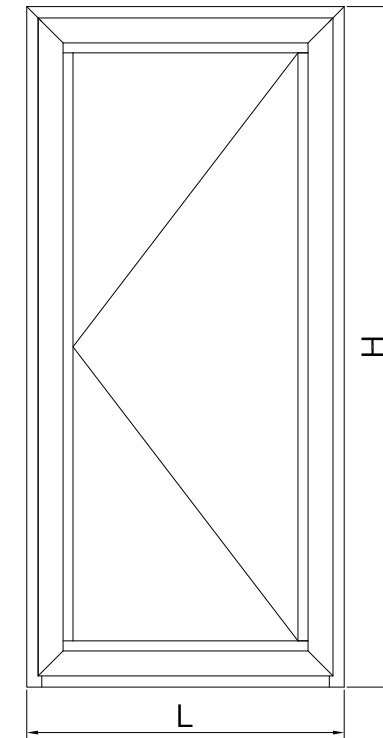

SECCIÓN PUERTA 2 HOJAS

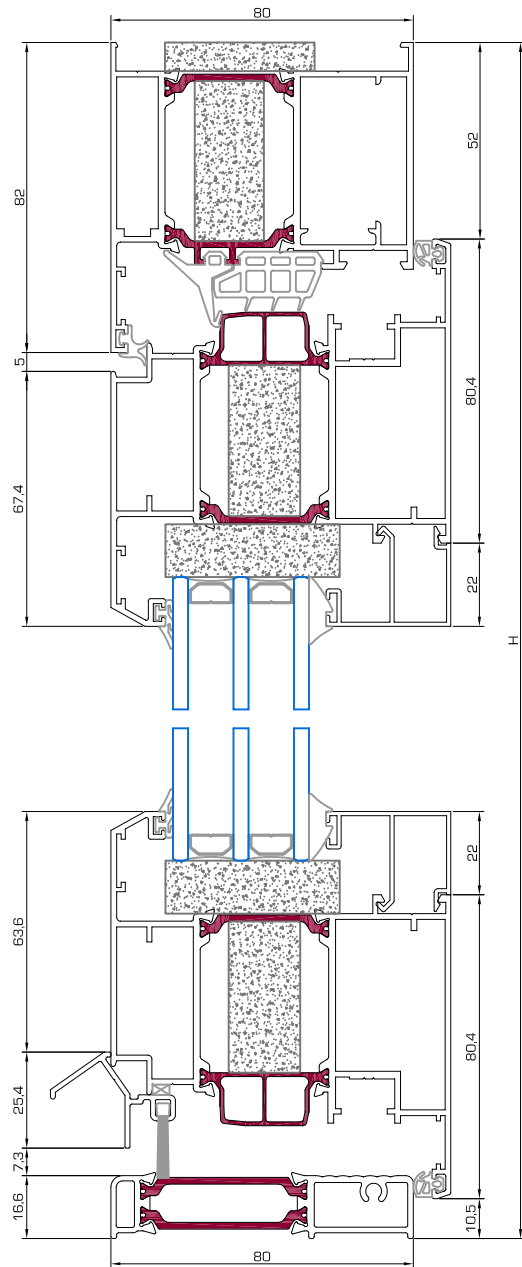

Ref.	Dibujo	Descripción	Corte	Uds.	Descuento
6020		Marco horizontal		1	L
		Marco vertical		2	H
6021		Hoja horizontal		4	(L - 109)/2
		Hoja vertical		4	H - 62,5
6002		Inversor		1	H - 181
xxxx		Solera		1	L - 110,6
5051		Perfil remate		2	(L - 255)/2
Junquillos Clip		Junquillo horizontal		4	(L - 430,4)/2
		Junquillo vertical		4	H - 267,3
Junquillos Grapa		Junquillo horizontal		4	(L - 430,4)/2
		Junquillo vertical		4	H - 223,3

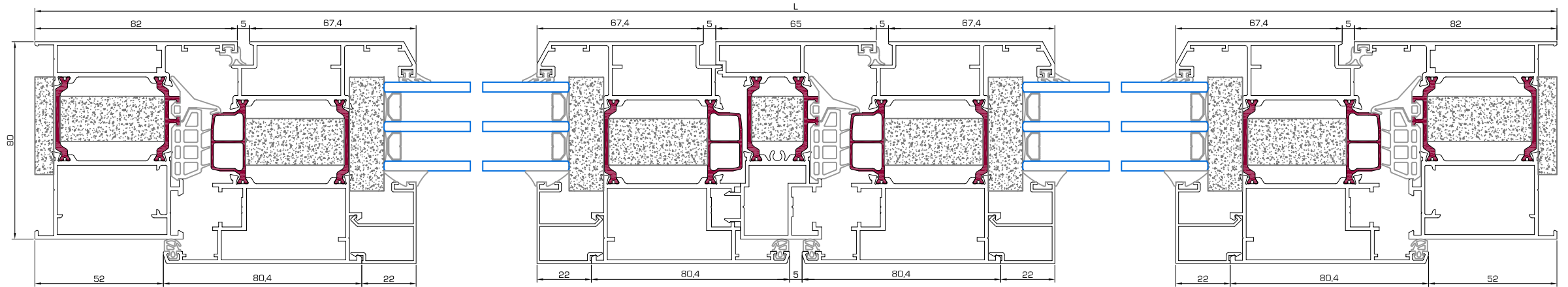
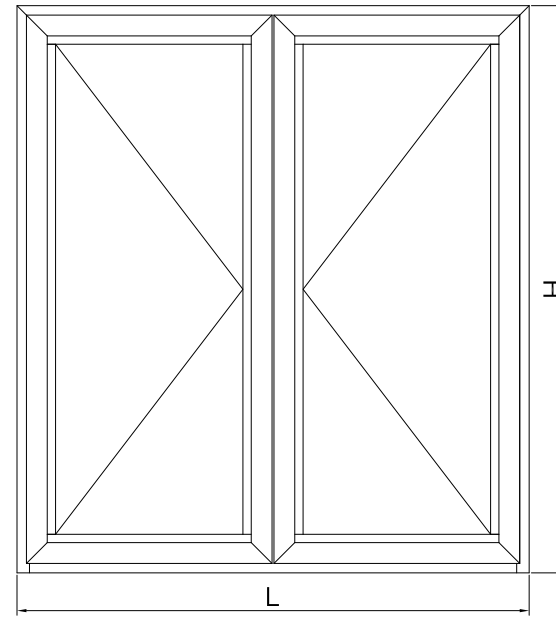



SECCIÓN PUERTA 1 HOJA CON FIJO LATERAL

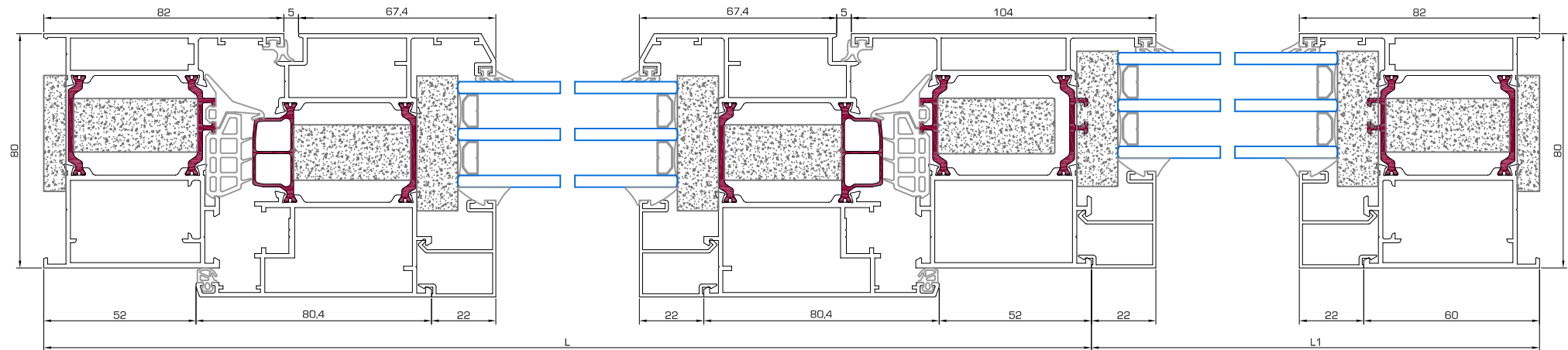
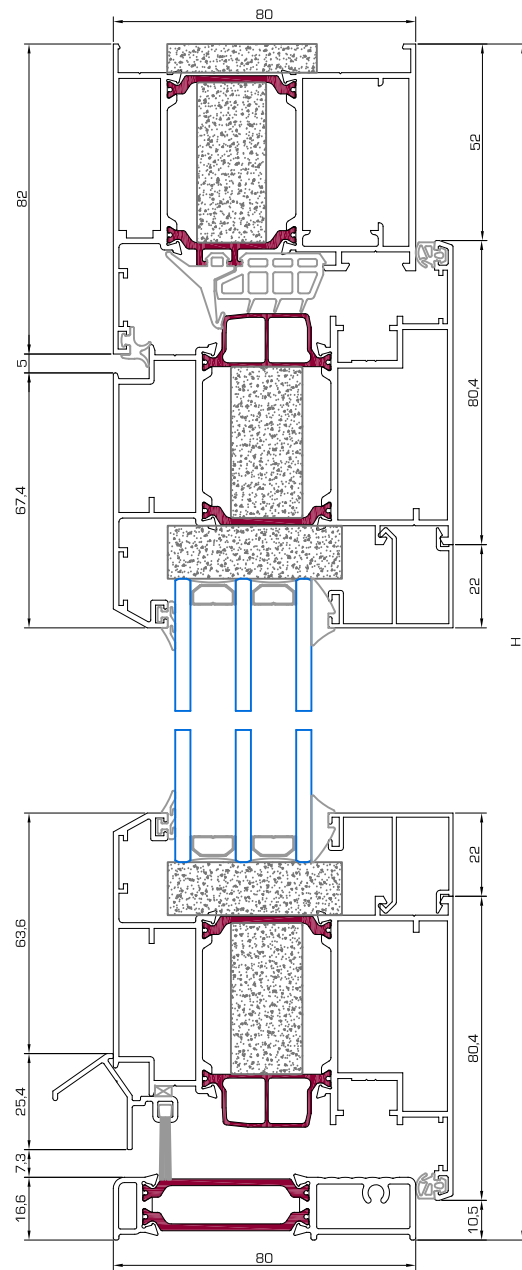

Ref.	Dibujo	Descripción	Corte	Uds.	Descuento
6020		Marco horizontal		1	L
		Marco horizontal		1	L1
		Marco vertical		1	H
		Marco vertical		1	H
6021		Hoja horizontal		2	L - 104
		Hoja vertical		2	H - 62,5
6024		Travesaño		1	L - 55,3
xxx		Solera		1	L - 110,6
5051		Perfil remate		1	L - 177
Junquillos Cip (hojas)		Junquillo horizontal		2	L - 264,8
		Junquillo vertical		2	H - 267,3
Junquillos Grapa (hojas)		Junquillo horizontal		2	L - 264,8
		Junquillo vertical		2	H - 223,3
Junquillos Cip (fijo)		Junquillo horizontal		2	L1 - 60
		Junquillo vertical		2	H - 144
Junquillos Grapa (fijo)		Junquillo horizontal		2	L1 - 60
		Junquillo vertical		2	H - 120

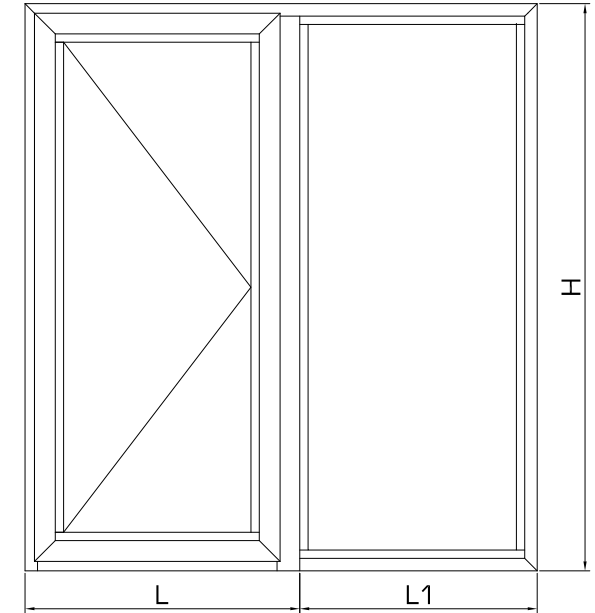

SECCIÓN PUERTA 1 HOJA CON FIJO SUPERIOR

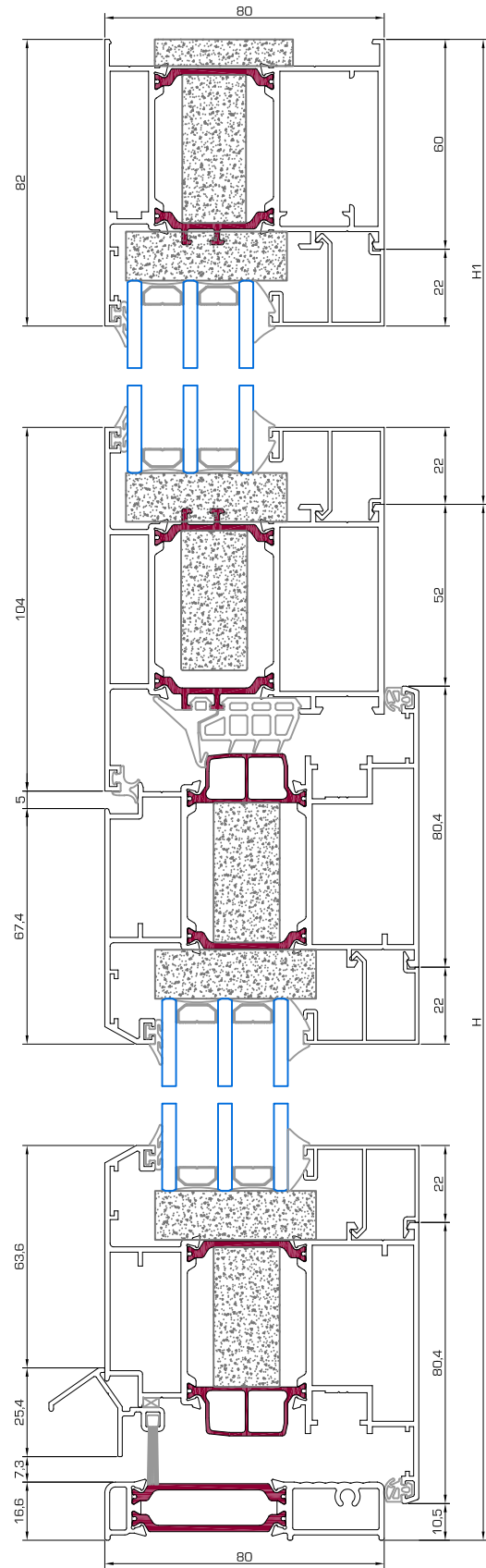

Ref.	Dibujo	Descripción	Corte	Uds.	Descuento
6020		Marco horizontal		1	L
		Marco vertical		2	H + H1
6021		Hoja horizontal		4	L - 104
		Hoja vertical		4	H - 62,5
6024		Travesaño		1	L - 110,6
xxx		Solera		1	L - 110,6
5051		Perfil remate		1	L - 177
Junquillos Clip (hojes)		Junquillo horizontal		4	L - 264,8
		Junquillo vertical		4	H - 267,3
Junquillos Grapa (hojes)		Junquillo horizontal		4	L - 264,8
		Junquillo vertical		4	H - 223,3
Junquillos Clip (fijo)		Junquillo horizontal		2	L - 120
		Junquillo vertical		2	H1 - 124
Junquillos Grapa (fijo)		Junquillo horizontal		2	L - 120
		Junquillo vertical		2	H1 - 60

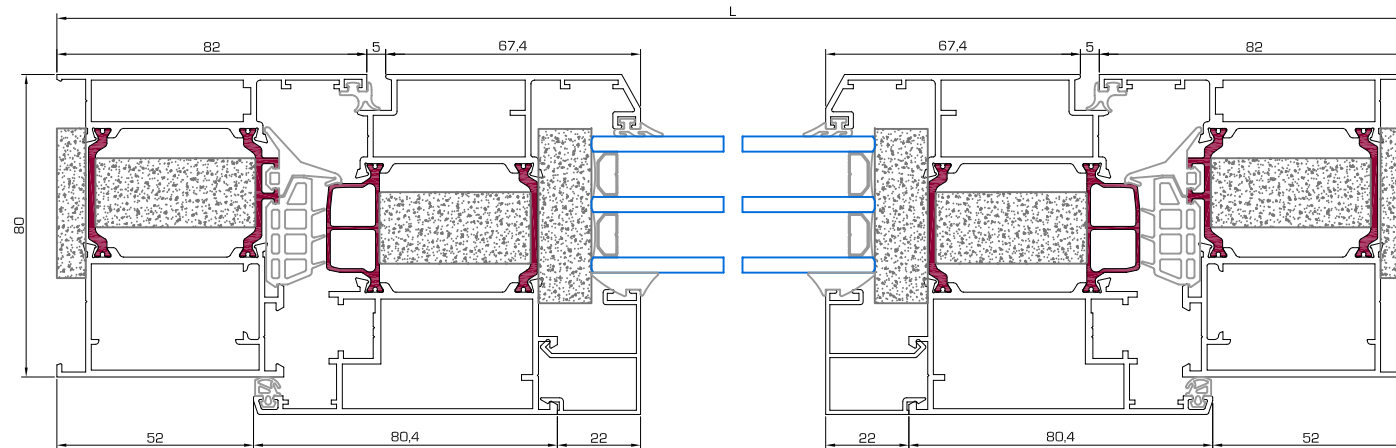
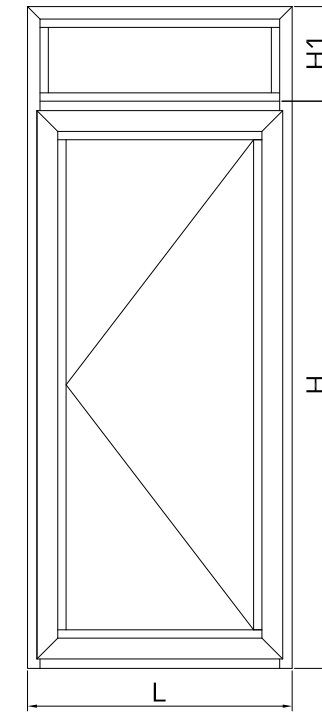

SECCIÓN PUERTA 2 HOJAS CON FIJO SUPERIOR

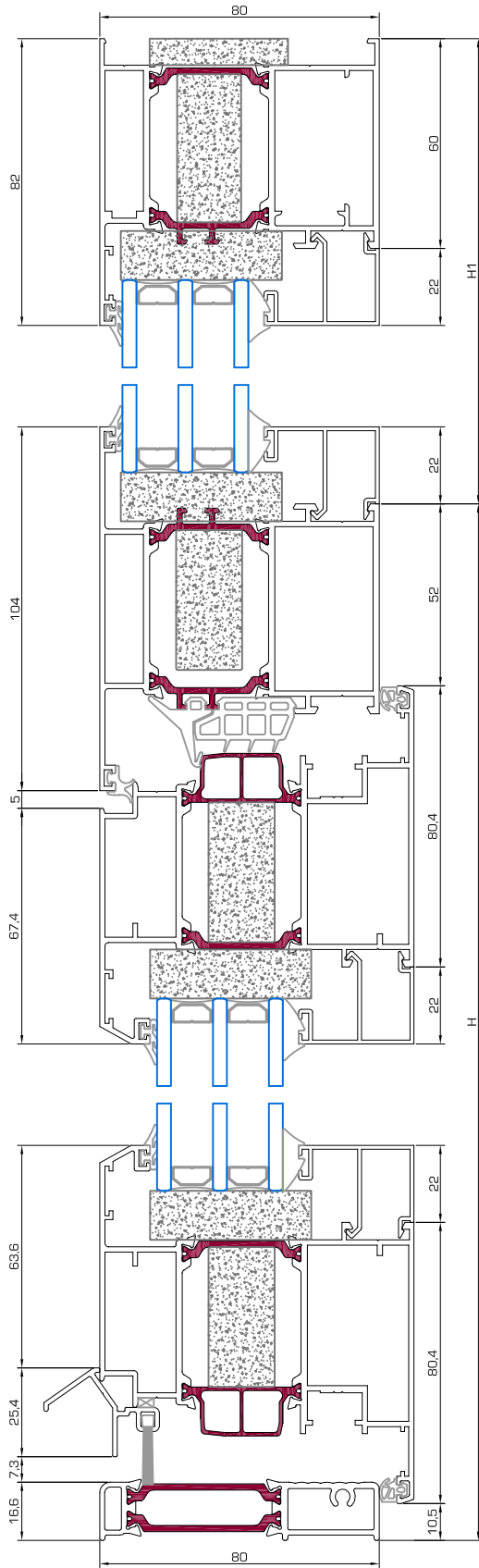

Ref.	Dibujo	Descripción	Corte	Uds.	Descuento
6020		Marco horizontal		1	L
		Marco vertical		2	H
6021		Hoja horizontal		4	(L - 109)/2
		Hoja vertical		4	H - 62.5
6002		Inversor		1	H - 181
6024		Travesaño		1	L - 110.6
xxx		Solera		1	L - 110.6
5051		Perfil remate		2	(L - 255)/2
Junquillos Clip (hoja)		Junquillo horizontal		4	(L - 430.4)/2
		Junquillo vertical		4	H - 267.3
Junquillos Grapa (hoja)		Junquillo horizontal		4	(L - 430.4)/2
		Junquillo vertical		4	H - 223.3
Junquillos Clip (fijo)		Junquillo horizontal		2	L - 120
		Junquillo vertical		2	H1 - 124
Junquillos Grapa (fijo)		Junquillo horizontal		2	L - 120
		Junquillo vertical		2	H1 - 60

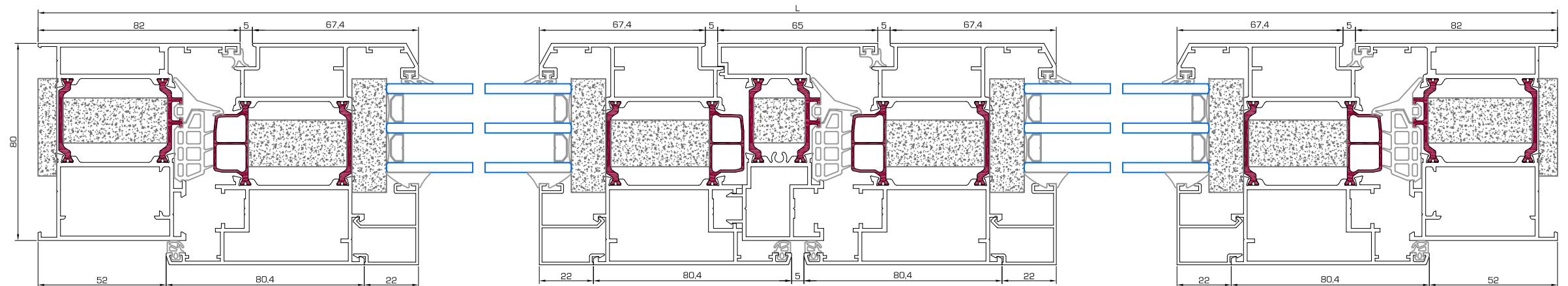
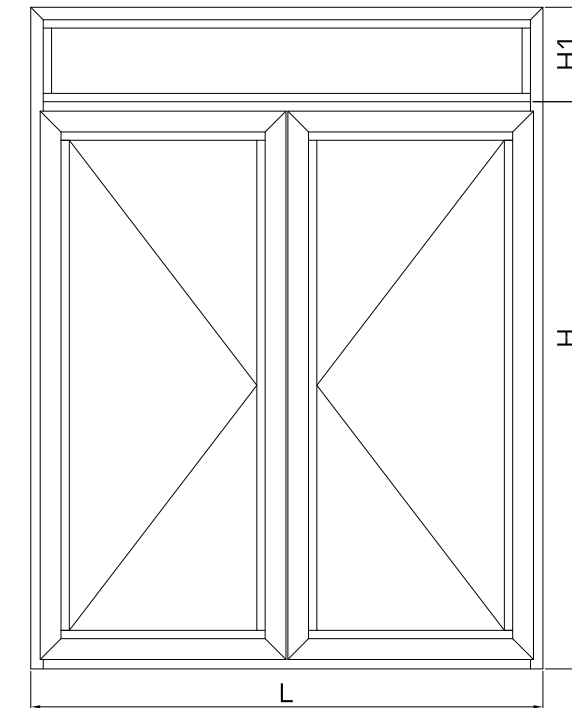

SECCIÓN APERTURA EXTERIOR 1 HOJA MARCO VENTANA

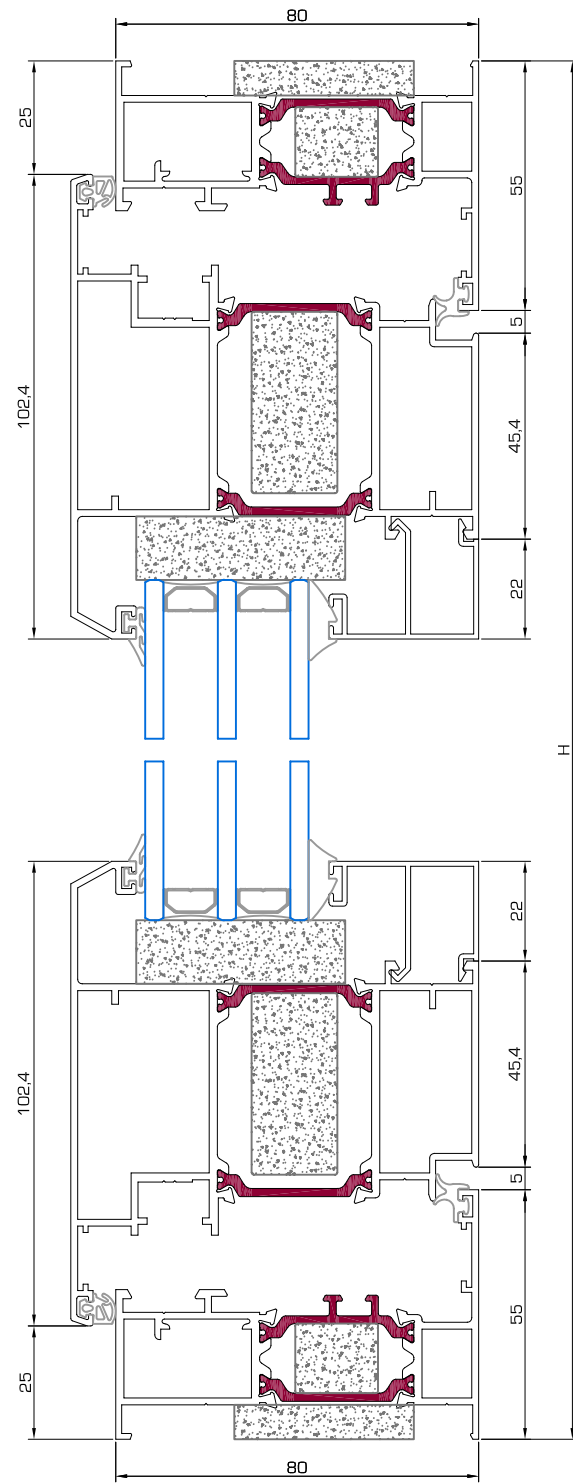

Ref.	Dibujo	Descripción	Corte	Uds.	Descuento
6000 6006 6007		Marco horizontal		2	L
6028		Marco vertical		2	H
6028		Hoja horizontal		2	L - 104
		Hoja vertical		2	H - 104
Junquillos Clip		Junquillo horizontal		2	L - 210,8
		Junquillo vertical		2	H - 254,8
Junquillos Grapa		Junquillo horizontal		2	L - 210,8
		Junquillo vertical		2	H - 210,8

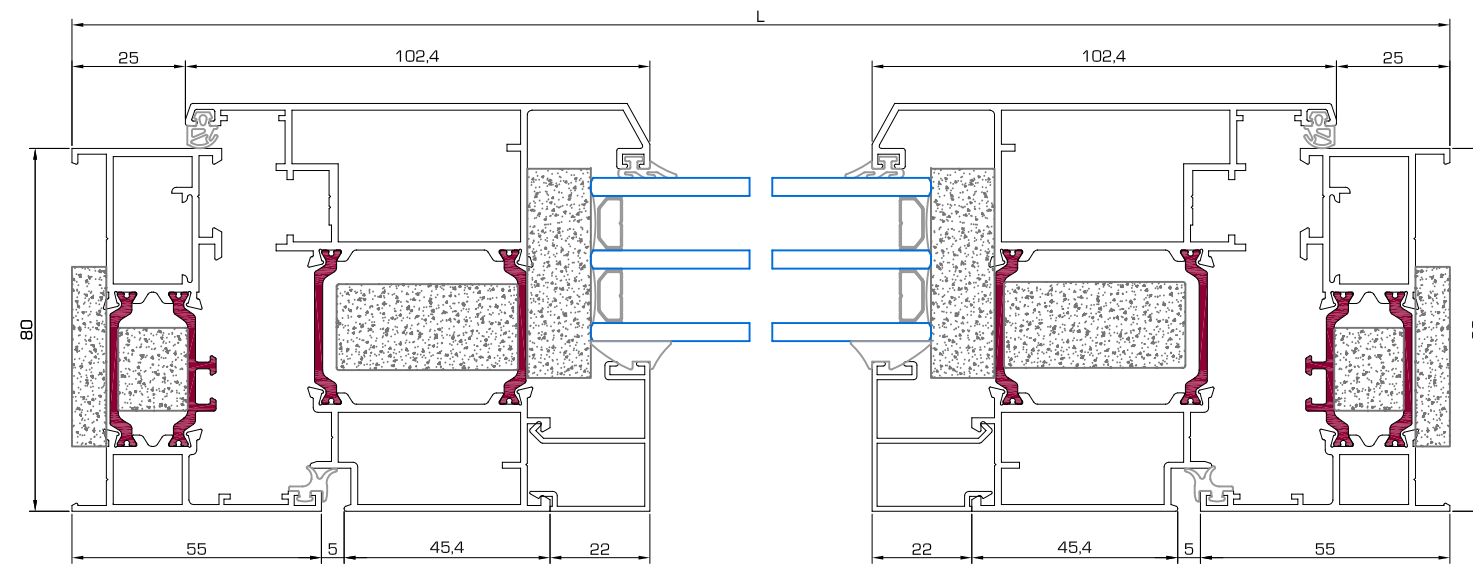
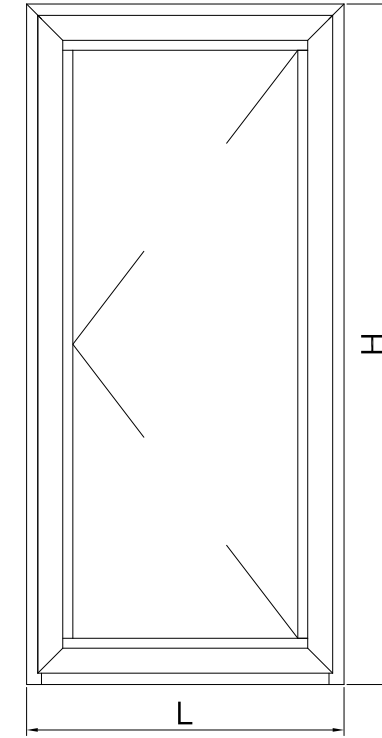



SECCIÓN APERTURA EXTERIOR 2 HOJAS MARCO VENTANA

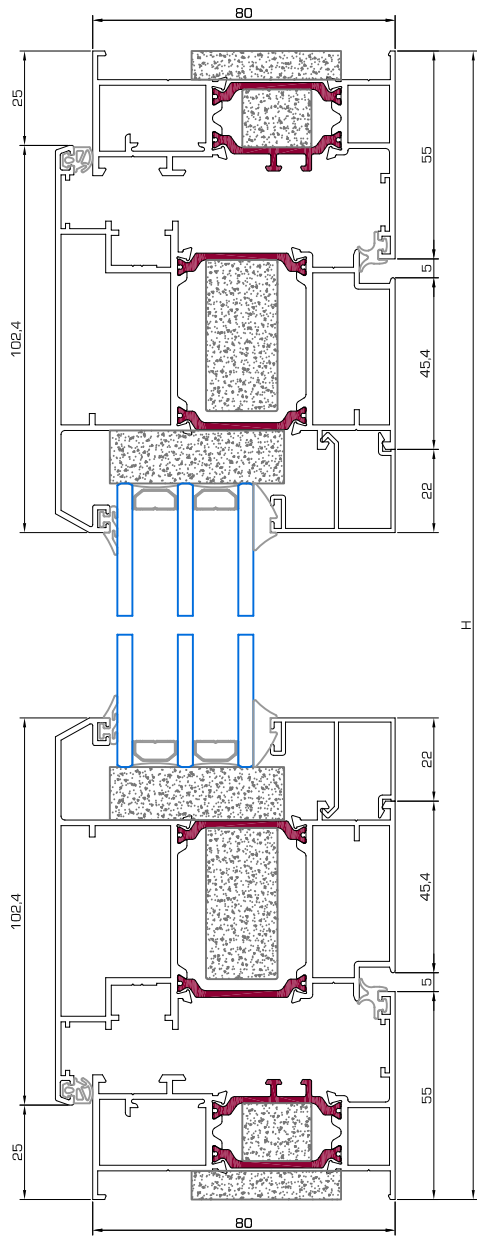

Ref.	Dibujo	Descripción	Corte	Uds.	Descuento
6000		Marco horizontal		2	L
6006		Marco vertical		2	H
6028		Hoja horizontal		4	(L - 109)/2
		Hoja vertical		4	H - 104
6002		Inversor		1	H - 127
Junquillos Clip		Junquillo horizontal Junquillo vertical		2	(L - 376,6)/2 H - 254,8
Junquillos Gropa		Junquillo horizontal Junquillo vertical		2	(L - 376,6)/2 H - 210,8

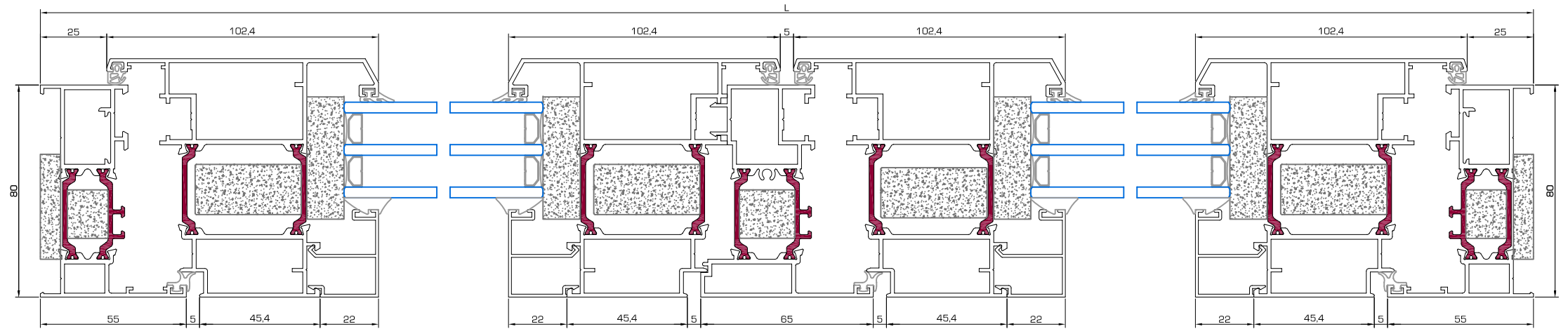
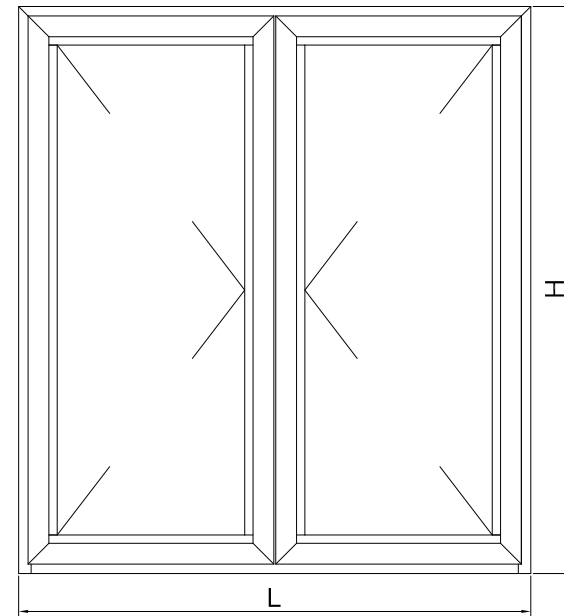



SECCIÓN APERTURA EXTERIOR 1 HOJA MARCO PUERTA

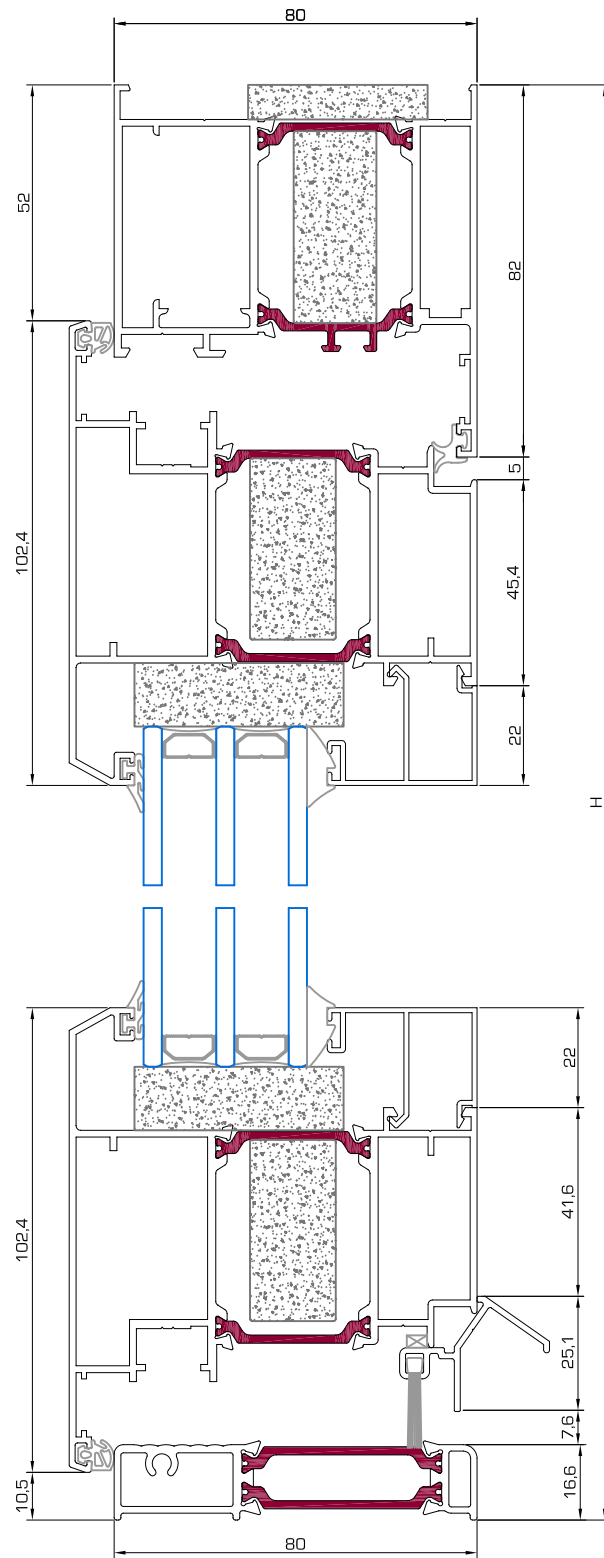

Ref.	Dibujo	Descripción	Corte	Uds.	Descuento
6020		Marco horizontal		1	L
		Marco vertical		2	H
6028		Hoja horizontal		2	L - 104
		Hoja vertical		2	H - 62,5
xxx		Solera		1	L - 110,6
5051		Perfil remate		1	L - 177
Junquillos Clip		Junquillo horizontal		2	L - 264,8
		Junquillo vertical		2	H - 267,3
Junquillos Grapa		Junquillo horizontal		2	L - 264,8
		Junquillo vertical		2	H - 223,3

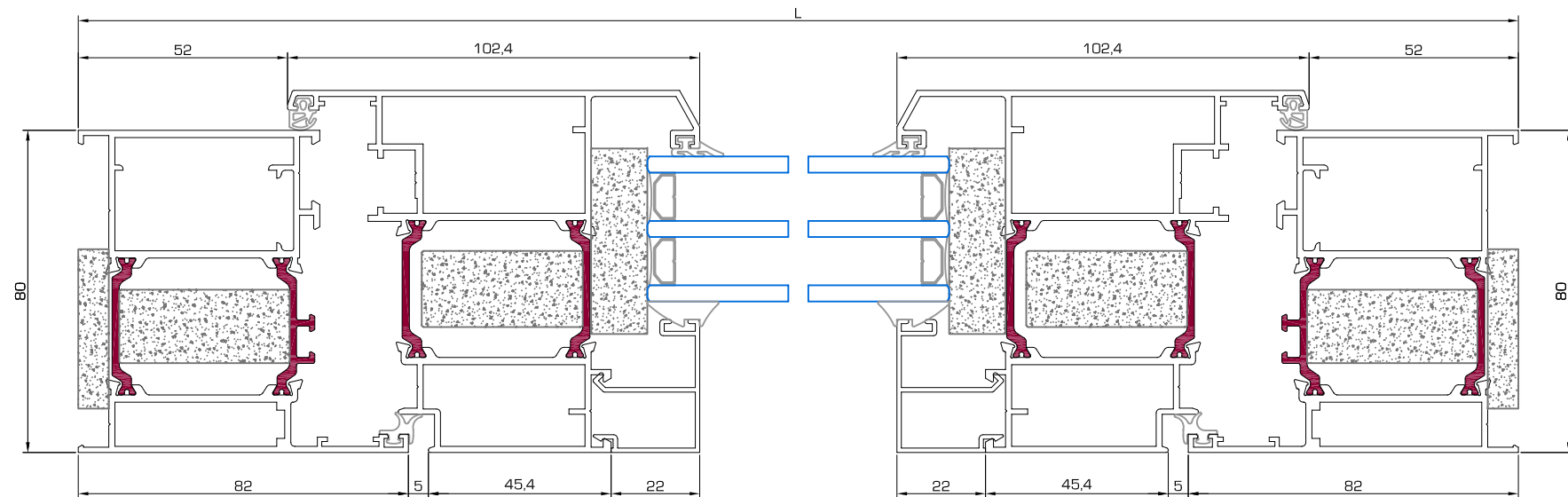
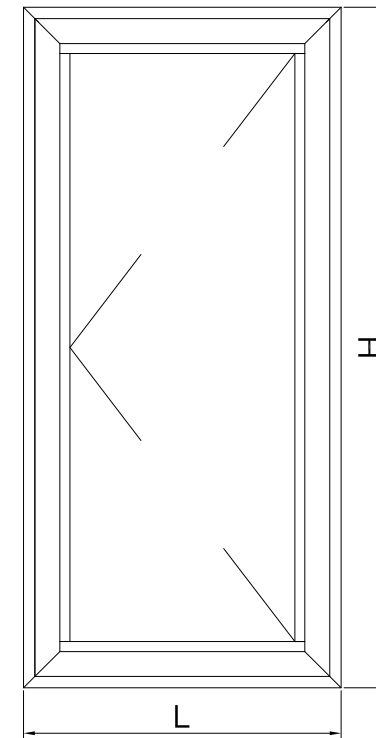

SECCIÓN APERTURA EXTERIOR 2 HOJAS MARCO PUERTA

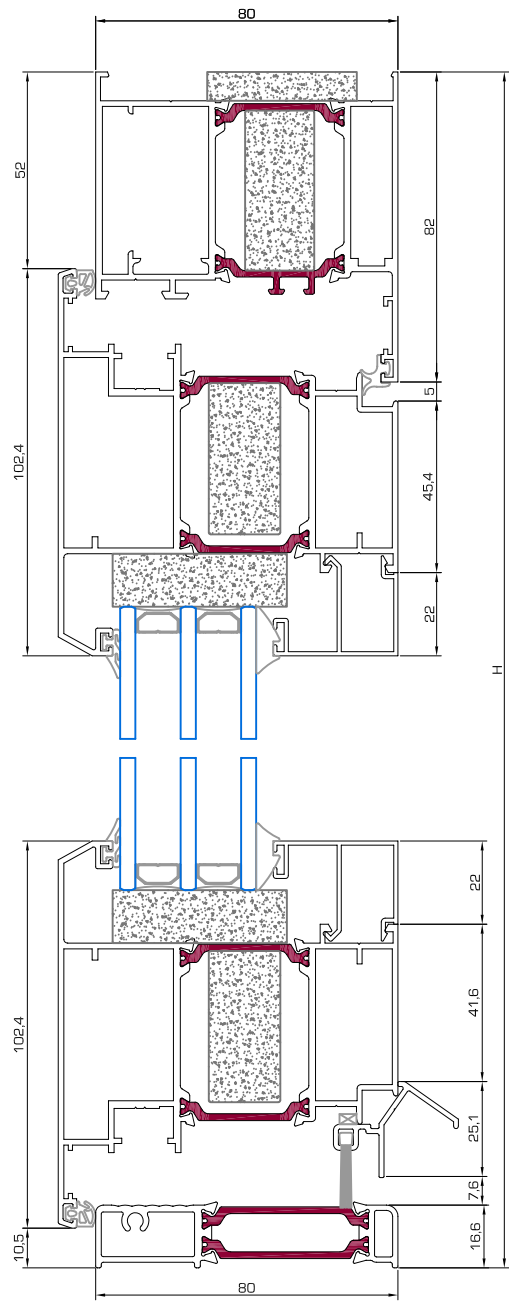

Ref.	Dibujo	Descripción	Corte	Uds.	Descuento
6020		Marco horizontal		1	L
		Marco vertical		2	H
6028		Hoja horizontal		4	L - 104
		Hoja vertical		4	H - 82,5
6002		Inversor		1	H - 127
xxxx		Solera		1	L - 110,6
5051		Perfil remate		2	L - 177
Junquillos Cfp		Junquillo horizontal		2	(L - 430,6)/2
		Junquillo vertical		2	H - 267,3
Junquillos Grapa		Junquillo horizontal		2	(L - 430,6)/2
		Junquillo vertical		2	H - 223,3

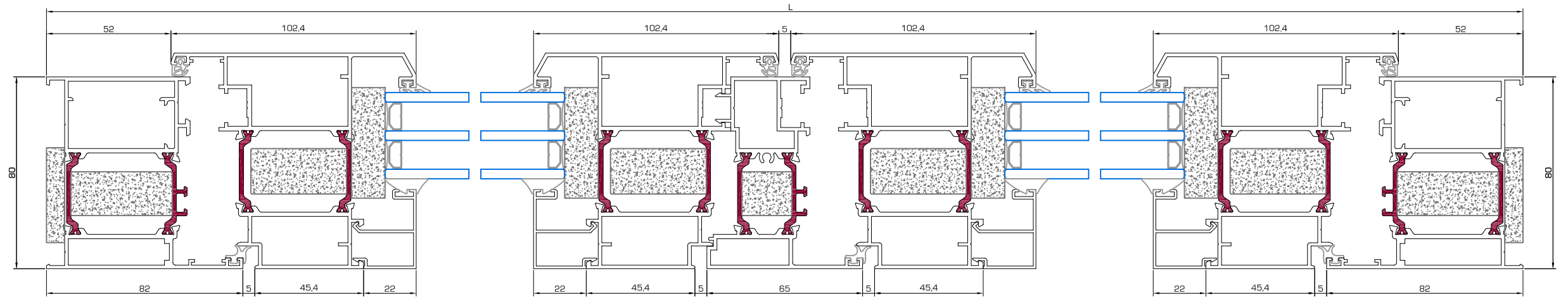
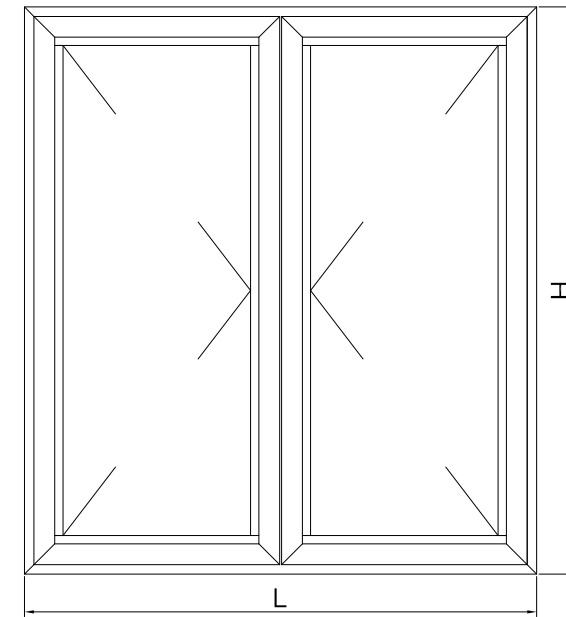

SECCIÓN FIJO-HOJA OCULTA

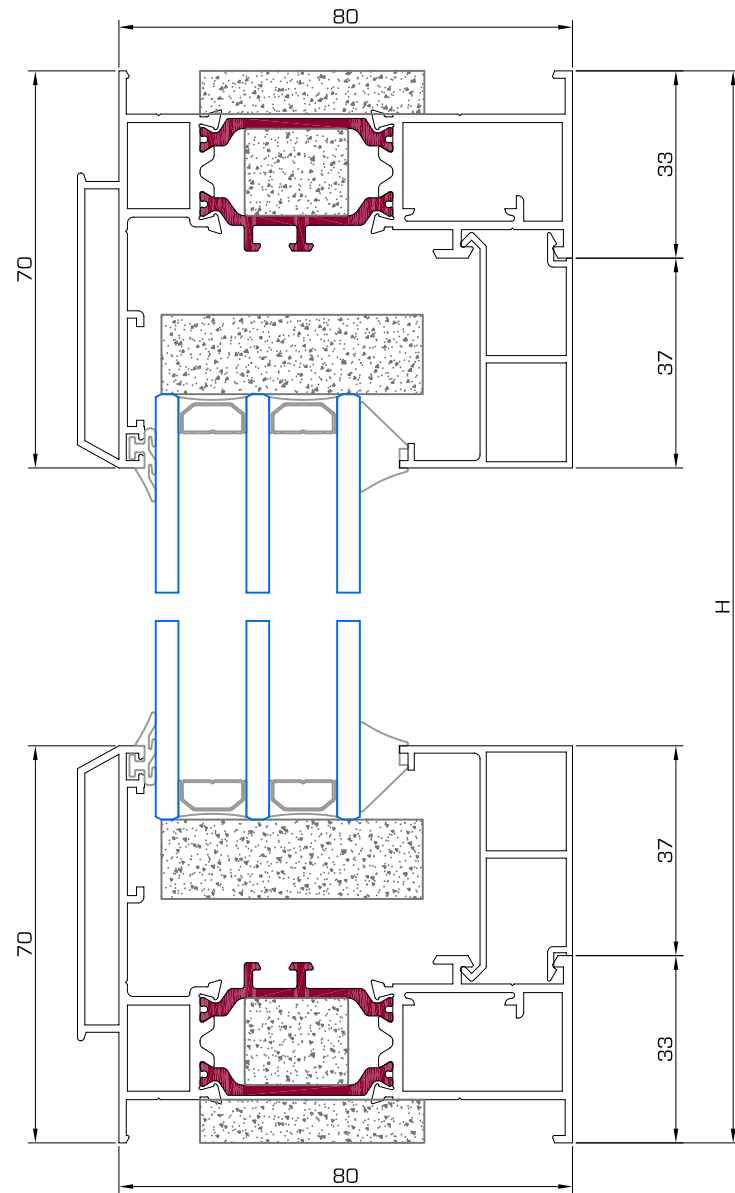

Ref.	Dibujo	Descripción	Corte	Uds.	Descuento
6050		Marco horizontal		2	L
6056		Marco vertical		2	H
Junquillos		Junquillo horizontal		2	L - 66
Clip		Junquillo vertical		2	H - 140

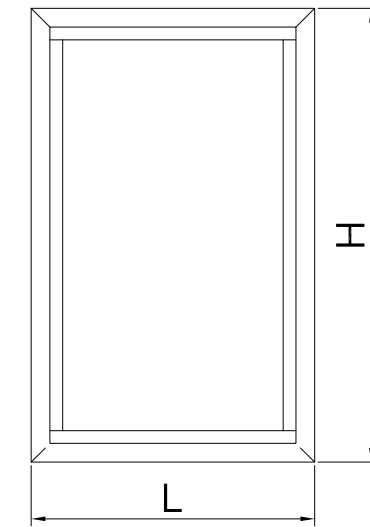
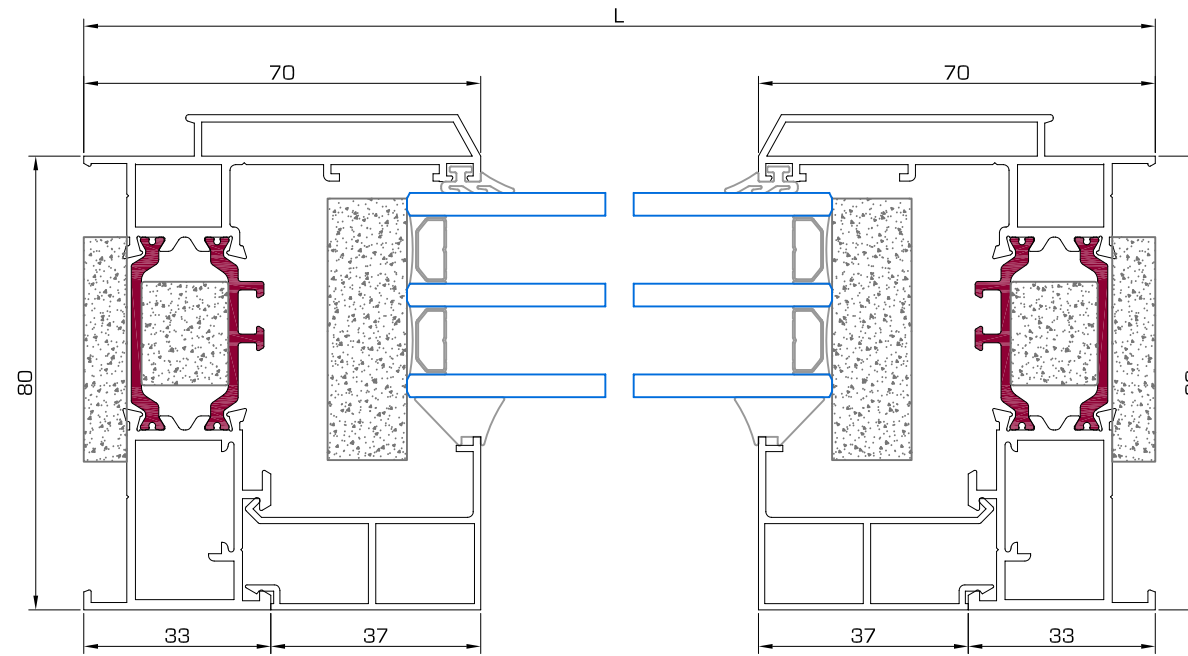

SECCIÓN VENTANA DE 1 HOJA-HOJA OCULTA

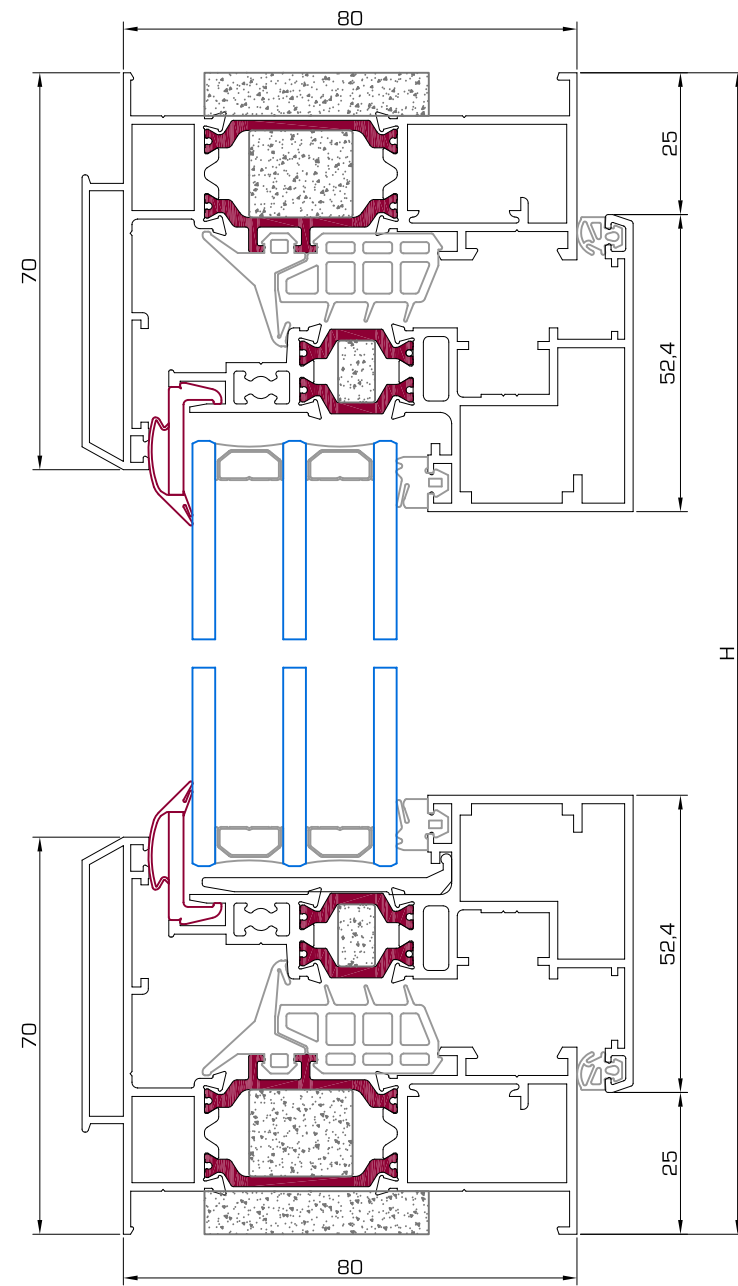

Ref.	Dibujo	Descripción	Corte	Uds.	Descuento
6050		Marco horizontal		2	L
6056		Marco vertical		2	H
6051		Hoja horizontal		2	L - 50
		Hoja vertical		2	H - 50
U080		Junquillo horizontal		2	L - 109,4
		Junquillo vertical		2	H - 109,4

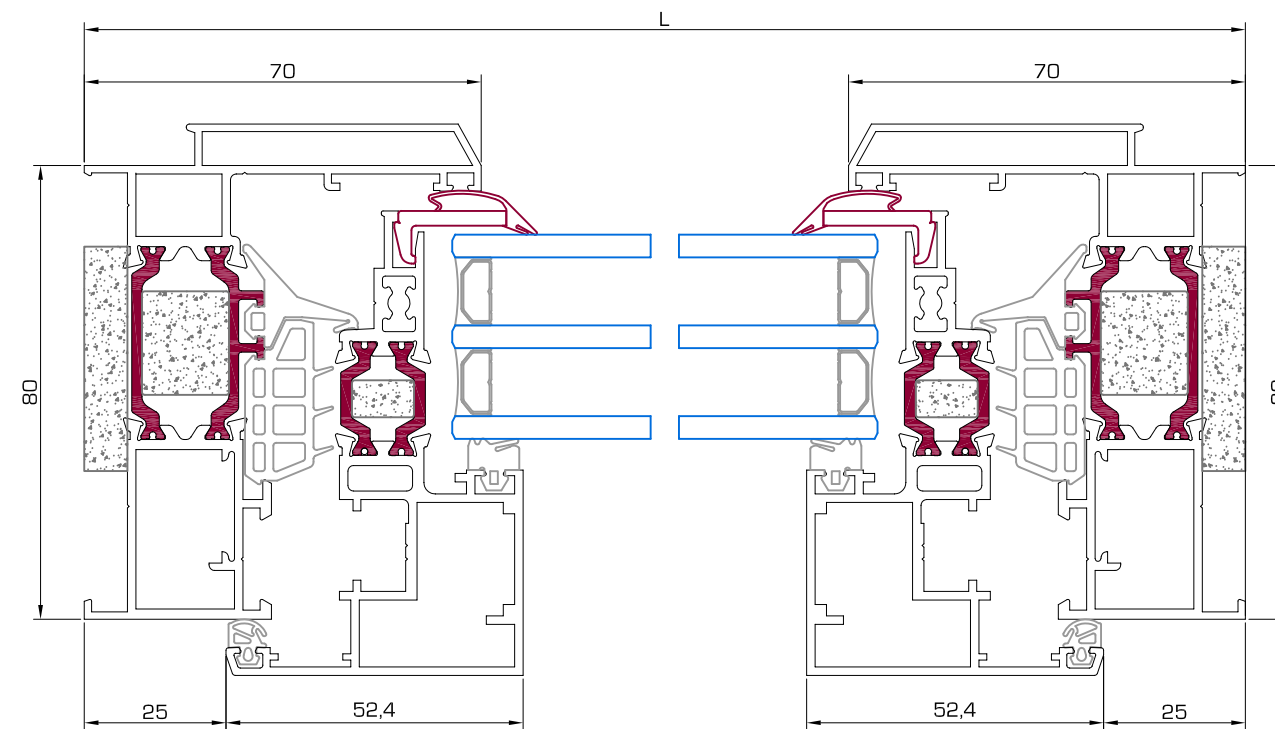
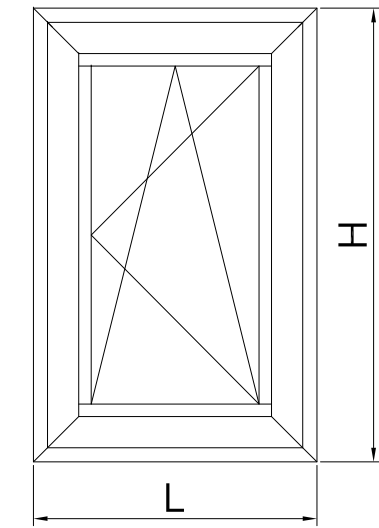

SECCIÓN VENTANA DE 2 HOJAS-HOJA OCULTA

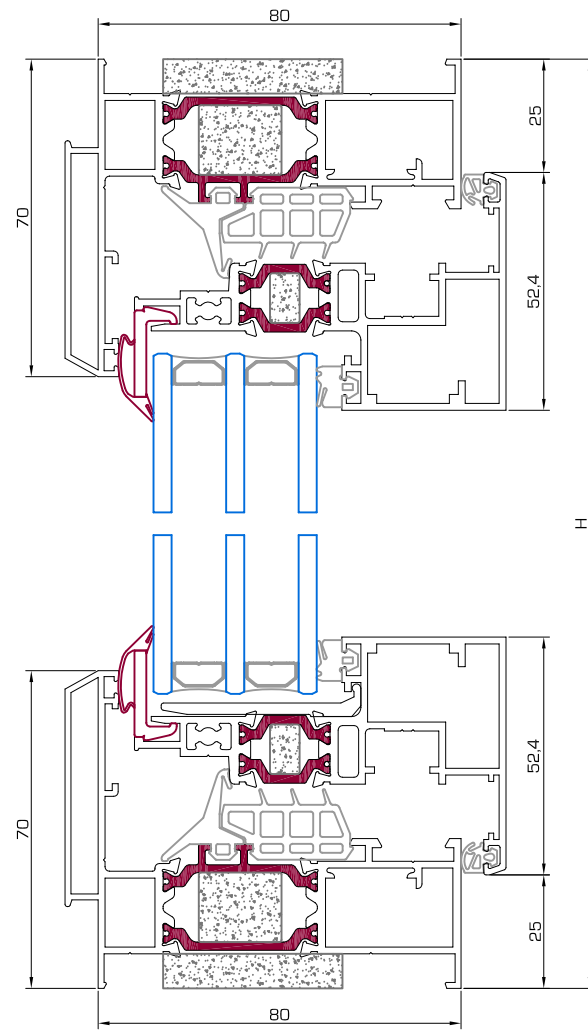

Ref.	Dibujo	Descripción	Corte	Uds.	Descuento
6050		Marco horizontal		2	L
6056		Marco vertical		2	H
6051		Hoja horizontal		4	$(L - 55) / 2$
		Hoja vertical		4	H - 50
6052		Inversor		1	H - 150
U080		Junquillo horizontal		4	$(L - 173,8) / 2$
		Junquillo vertical		4	H - 109,4

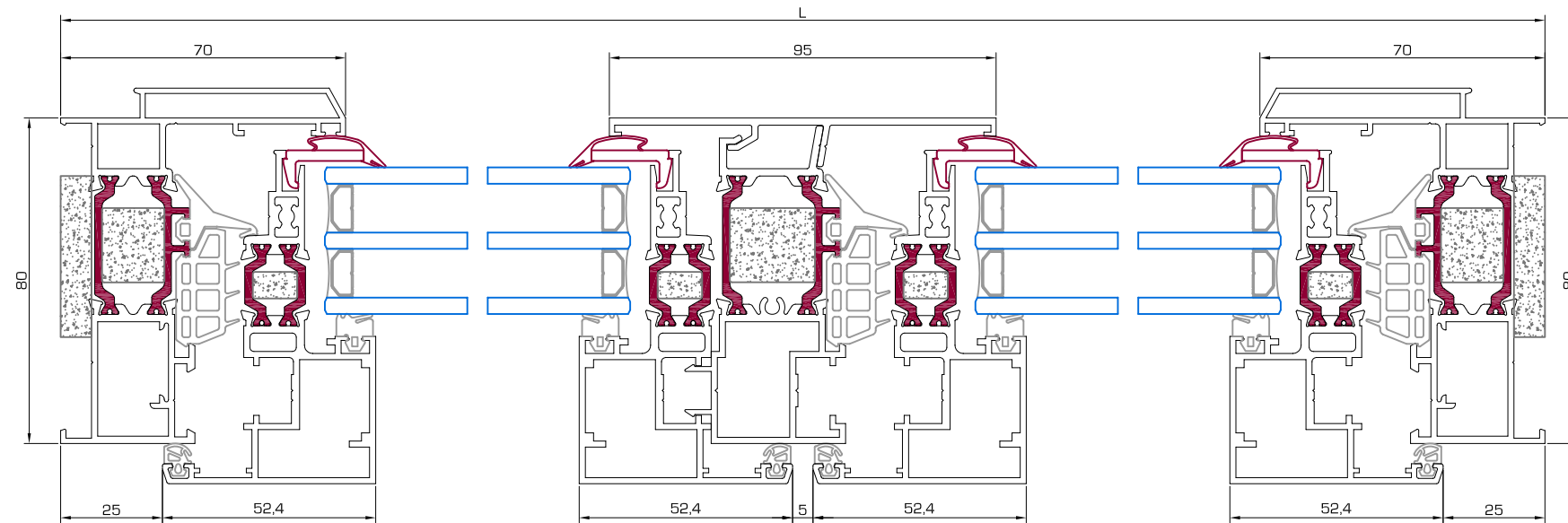
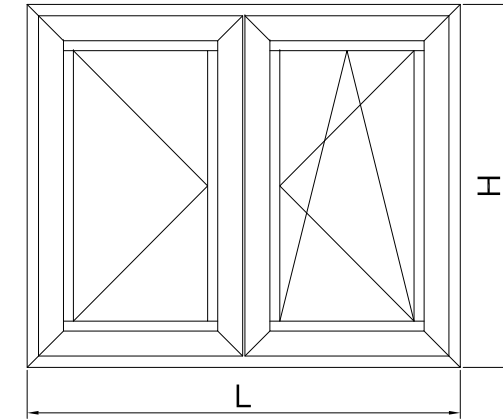

SECCIÓN VENTANA DE 1 HOJA CON FIJO-HOJA OCULTA

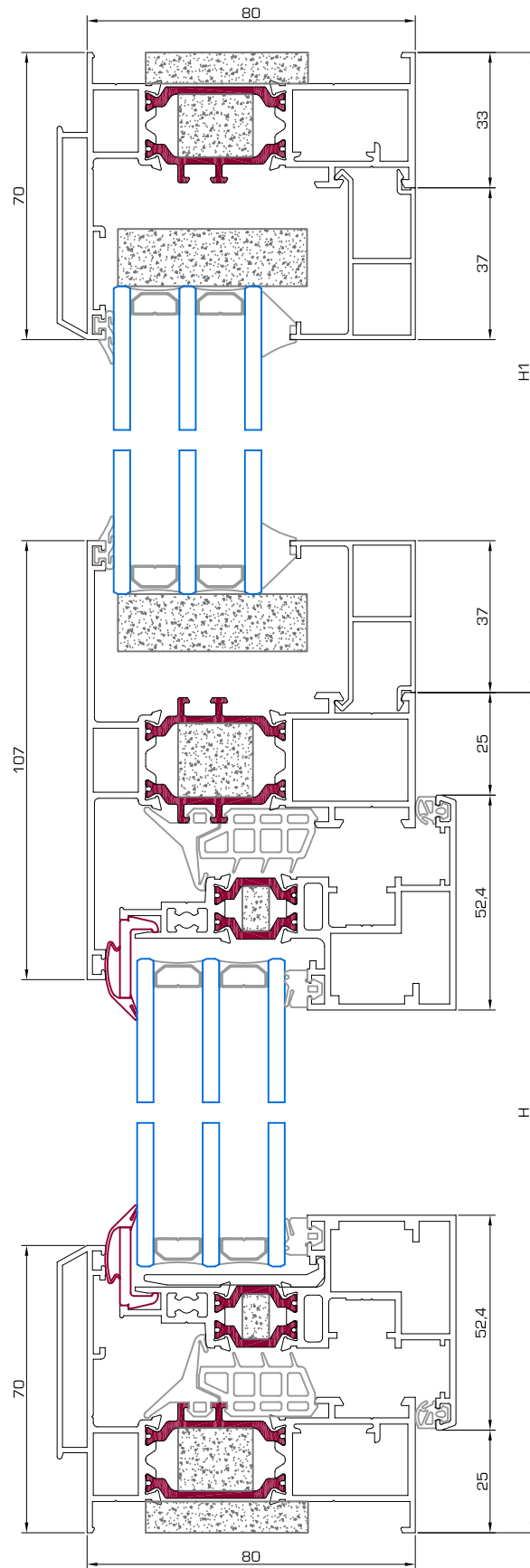

Ref.	Dibujo	Descripción	Corte	Uds.	Descuento
6050 6056 6057		Marco horizontal		2	L
6051		Marco vertical		2	H
6054		Travesaño		1	L - 56,6
U080		Junquillo horizontal		2	L - 109,4
		Junquillo vertical		2	H - 109,4
Junquillos Clip (fijo)		Junquillo horizontal		2	L - 66
		Junquillo vertical		2	H1 - 140

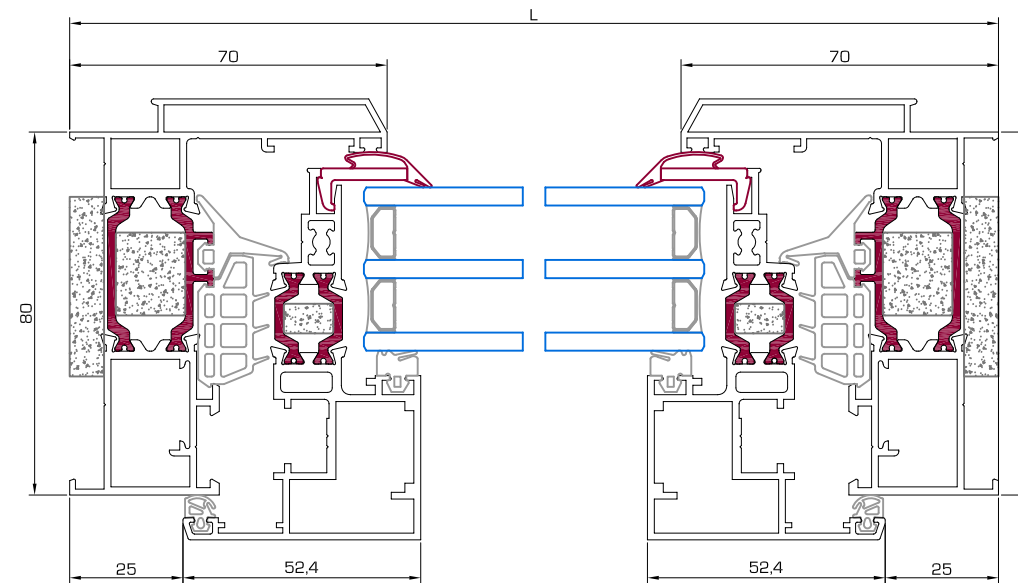
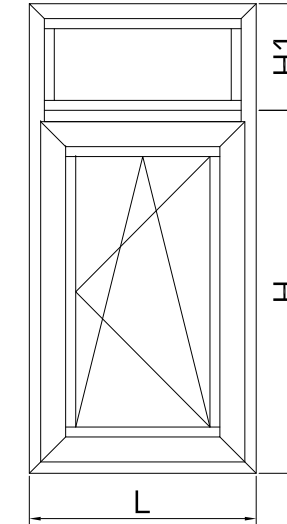

SECCIÓN VENTANA DE 2 HOJAS CON FIJO-HOJA OCULTA

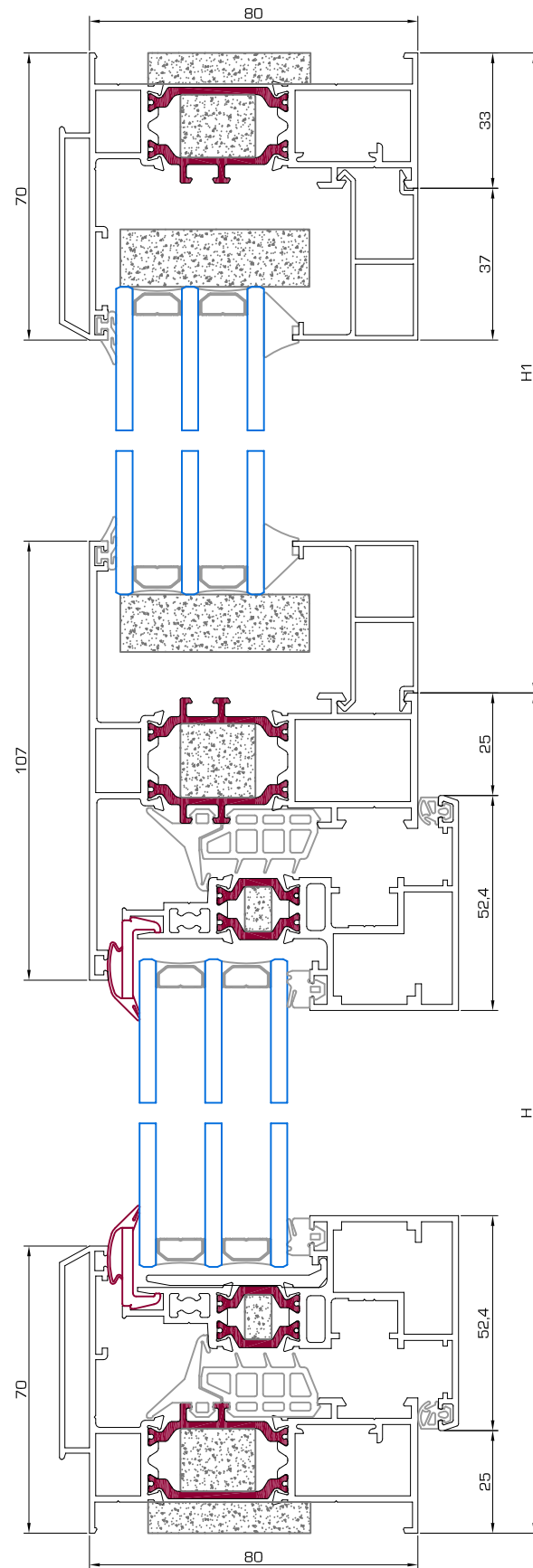

Ref.	Dibujo	Descripción	Corte	Uds.	Descuento
6050		Marco horizontal		2	L
6056		Marco vertical		2	H
6051		Hoja horizontal		4	$(L - 55)/2$
		Hoja vertical		4	H - 50
6052		Inversor		1	H - 150
6054		Travesaño		1	L - 56,6
U080		Junquillo horizontal		4	$(L - 173,8)/2$
		Junquillo vertical		4	H - 109,4
Junquillos Clip (fijo)		Junquillo horizontal		2	L - 66
		Junquillo vertical		2	H1 - 140

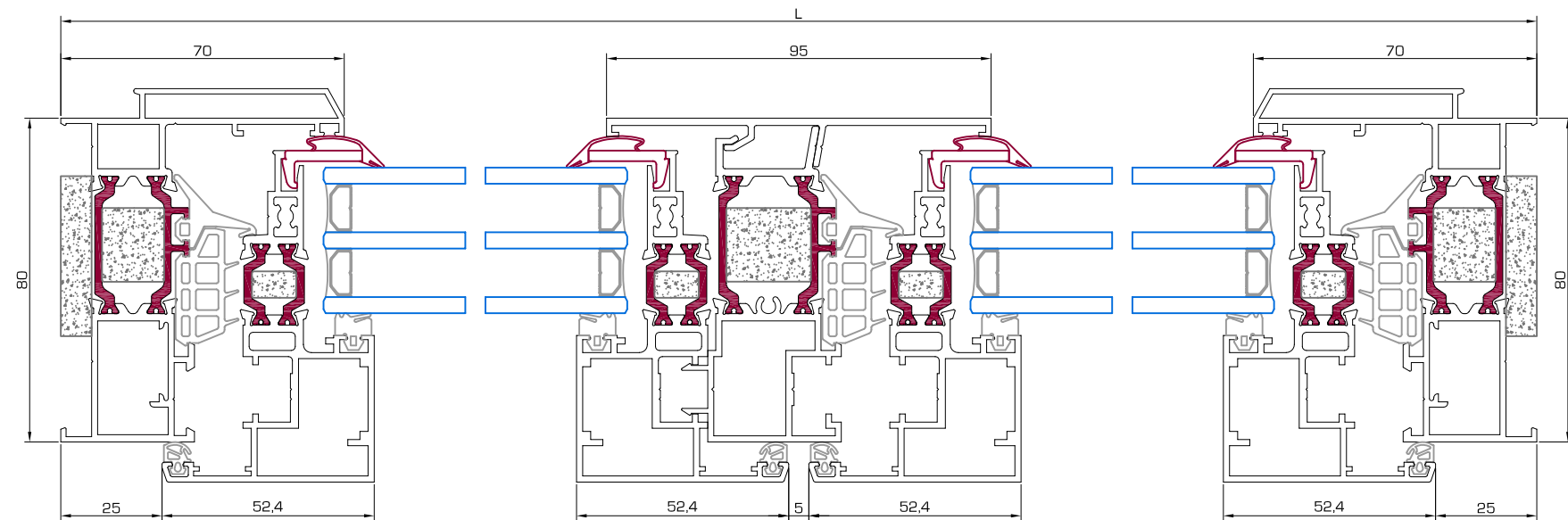
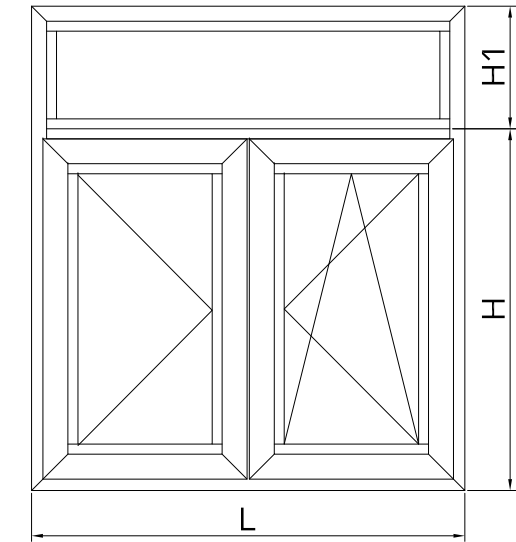



CODALMHA, S.L.

COMERCIAL DEL ALUMINIO

C/ NOGAL, 14 POLIGONO INDUSTRIAL LOS HUERTECILLOS
28350 - CIEMPOZUELOS (MADRID)
Tif: 91.893.18.28 Fax: 91.893.18.36
www.codalmha.com
info@codalmha.com